

IWAKI
Electromagnetic Metering Pump

EHN-NAE

Instruction Manual

 Read this instruction manual before use of product

Thank you for having selected IWAKI's EHN type electromagnetic metering pump.
 This instruction manual, which is divided into 5 sections, namely "Safety Section," "Outline Section," "Installation Section," "Operation Section" and "Maintenance Section," deals with the correct handling and operation procedures for the pump.
 Read this manual prior to using the pump, to ensure safe and long operation.



Contents

Instruction for safety	1-3
Outline of product	
1. Unpacking and inspection	4
2. Principle of operation	4
3. Automatic air vent	5
4. Model identification	5-6
5. Specification	6-7
6. Operating function	7-8
7. STOP function	8
8. Overview	9-10
Installation	
1. Before installation	11
2. Precaution on handling	11-12
3. Installation	13
4. Tubing	14-15
5. Electrical wiring	16-20
Operation	
1. Operation	21-24
2. Operation of controller	25-36
Maintenance	
Instruction for safety	37
1. Troubleshooting	37-38
2. Maintenance and inspection	38
3. Wear parts	39
4. Disassembling and assembling	40-44
Exploded view	45-47
Outline dimension	48

Instruction for safety

For the Safe and Correct Handling of the Pump

- Read the "Safety Instructions" sections carefully to prevent accidents involving your customers or other personnel and to avoid damage or loss of other assets. Always follow the instructions and advice found in these sections.
- Observe and abide by the instructions described in this manual. These instructions are very important for protecting pump users from dangerous conditions and situations related with the use of the pump system.
- The symbols relate to the following meanings described below:

 Warning	Nonobservance or misapplication of the contents of the "Warning" section could lead to a serious accident, including death or injury.
 Caution	Nonobservance or misapplication of the contents of the "Caution" section could lead to serious physical injury to the user or serious damage to the product.

Types of Symbols



Indicates a prohibited action or procedure. Inside or near this circle, a concrete and practical image of the activity to be avoided is depicted.



Indicates an important action or procedure which must be performed or carried out without fail. Failure to follow the instructions herein can lead to malfunction or damage to the pump.

Instruction for safety

Warning

- **Turn off the power supply.**
Working without disconnecting the power supply may cause an electrical shock. Before engaging upon any working procedures involving the pump, make sure to turn the power supply switch off and to stop the pump and other related devices.
- **Terminate operation**
When you detect or become aware of a dangerous sign or abnormal condition during operation, terminate the operation immediately and start it from the beginning again.
- **For specified application only.**
The use of a pump in any application other than those clearly specified may result in injury or damage to the pump. Use the pump strictly in accordance with the pump specifications and application range.
- **No remodeling**
Never remodel or modify a pump. Otherwise, a serious accident may result. IWAKI will not be responsible for any accident or damage of any kind which is caused by the user remodeling the pump without first obtaining permission or instructions from Iwaki.
- **Wear protectors.**
If you touch or come in contact with any type of hazardous chemical liquid, including but not limited to chemicals, you may experience a serious injury. Wear protector (protective mask, gloves, etc.) during the works.



Caution

- **Qualified operators only**
The pump operator and pump operation supervisor must have the knowledge of the pump to operate the pump.
- **Specified power only.**
Do not operate the pump with voltage which is not specified on the nameplate. Otherwise damage or fire will may happen. Only the specified power source must be used.
- **Pay attention to dry running.**
Do not run pump dry for more than 30 minutes. If pump runs dry for more than 30 minutes, screws of pump head will be loosened and may result in liquid leakage. Install the pump so that dry running can not occur. Also, when bleeding is done, do not run pump dry for more than 30 minutes.
- **Do not wet or dampen.**
If an electric part or wiring gets wet with the liquid spilled over accidentally, a fire or electrical shock may be caused. Install the system in a place free from liquid spillage or leakage.
- **Ventilate.**
Poisoning may result during an operation which involves toxic or odorous liquid. Ventilate the operating site sufficiently.



Instruction for safety

Caution

- **Limited operating site and storage**
Do not install or store the pump in the following places:
 - * Places where a flammable gas or material is used or stored.
 - * Places where the ambient temperature is extremely high (40 dig.C or higher) or extremely low (0 dig.C or lower).
- **Spill-out accident**
Protective measures should be taken against any accidental spill-out or leakage of the operating liquid as a result of unexpected damage on the pump or the related piping.
- **Humid place prohibited**
The pump is not water-proof construction. If the pump is used at place where liquid is splashed on pump or at humid place, electrical shock or short-circuit may happen.
- **Do not damage or change power cable.**
Do not scratch, damage, process, or pull the power cable forcibly. An extra load onto the cable, such as heating the cable or placing something heavy on the cable, may damage the cable and finally cause a fire or an electrical shock.
- **Arrange grounding.**
Do not operate the pump without connecting the grounding wire. Otherwise, an electrical shock may result. Make sure the grounding wire is connected with the grounding terminal.



Prohibited



Caution



Prohibited



Caution



Grounding

Caution

- **Install an earth leakage breaker (option).**
The operation of a pump without using an earth leakage breaker may cause an electrical shock. Please purchase an optional leakage breaker and install in the system.
- **Handling of power cable**
Use of a defective or damaged power cable may result in a fire or electrical shock. Handle the power cable carefully.
- **Follow the instruction manual.**
Replace the consumable parts by following the descriptions in the instruction manual. Do not disassemble the pump beyond the extent shown on the instruction manual.
- **Damaged pump**
Never operate a damaged pump. A damaged pump may cause leakage or electrical shock.
- **Disposal of used pump**
Disposal of used or damaged pumps must be done in accordance with the relevant local laws and regulations. (Consult a licensed industrial waste products disposing company.)



Electrical Shock



Electrical Shock



Prohibited



Outline of product

1. Unpacking and inspection

1) Check the model code, the discharge capacity, the discharge pressure and the voltage shown on the nameplate corresponds to your order.

2) Check that all accessories are in place.

a. A check valve

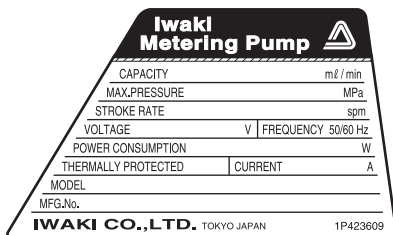

Model	Set press. MPa	Connection mm	Wet-end material	Applied pump model	Pump wet-end material code
Check valve	0.17	∅4 × ∅9	PVC	EHN-B11-16-C16-21	VC
					VH

b. Hose for tubing 3 m × 1 pc (4 × 9 dia. PVC braided hose)

3) Check that the product is not damaged or any bolts or nuts are not loosened during the transit by visual check or touch.

Note: If you find any abnormality, ask your supplier.

2. Principle of operation

IWAKI electromagnetic metering pump EHN series is diaphragm type metering pumps of which diaphragm is directly driven by the electromagnet force consist of a pump head, a driving unit and a control unit. Reciprocating movement is made by the force of spring and the electromagnet generated by the pulse current comes from a control unit. The reciprocating movement is transferred to the diaphragm which is connected to a plunger to make the volumetric change in pump chamber. Pumping effect is obtained by the volumetric change and by the effect of valves which are mounted in pump head.

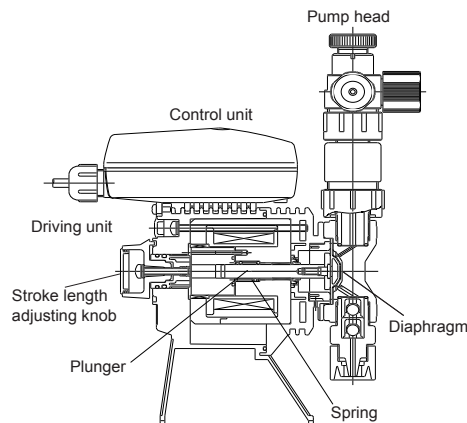

Outline of product

3. Automatic air vent

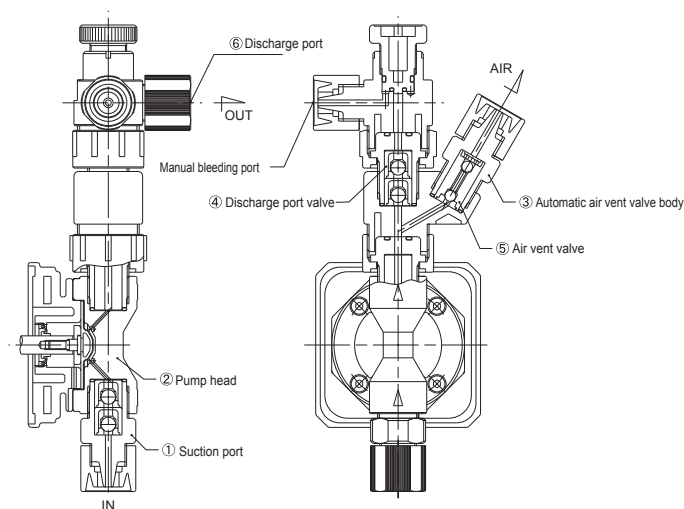

- The air entering through ①Suction port is transferred to ③Automatic air vent valve body via ②Pump head.
- The air is transferred to Air vent valve body due to the different motion between ④Discharge port valves and ⑤Air vent valves, and exhausted into an atmosphere or a chemical tank.
- While the air is exhausted, liquid is transferred to the discharge side tubing through ⑥Discharge port as exhausting a part of the liquid through ③Automatic air vent valve body.

4. Model identification

Pump : **EHN - B 11 VC 1 R - NAE**

1 2 3 4 5 6 7

1. Series
EHN multi voltage type
2. Driving unit code (Average power consumption)
B : 20W C : 24W
3. Diaphragm effective diameter
11 : 10mm 16 : 15mm 21 : 20mm
4. Wet-end material

Code	Pump head	Valve ball	O ring	Valve seat	Gasket	Diaphragm
VC	PVC	Ceramic	FKM	FKM	PTFE	PTFE + EPDM (Not wet-end)
VH		Hastelloy C	EPDM	EPDM		

Material code PVC: Transparent polyvinyl chloride FKM: Fluor rubber (Acid resistant Viton®)
PTFE: Poytetrafluro ethylene(Teflon®) EPDM: Ethylene propylene rubber

5. Material of automatic air vent valve body (Wet-end material)

Code	Air vent valve guide A	Air vent valve guide B	Valve	Separate Pin	Valve seat	O ring
VC	PVC	PVC	Ceramic	Titanium	FKM	FKM
VH	PVC	PVC	Hastelloy C	Hastelloy C	EPDM	EPDM

Material code PVC: Transparent polyvinyl chloride FKM: Fluor rubber (Acid resistant Viton®)
EPDM: Ethylene propylene rubber

Outline of product

5. Connection hose diameter code

Connected hose dia.	Kind
∅ 4 × ∅ 9	Transparent PVC braid hose

6. Controller function code

R: Standard type

7. Special type code

NAE: Automatic air vent type.

Control unit : EHNC - B R - □□
 1 2 3 4

1. Control unit type

EHNC: Multi voltage type (with crimp contact)

2. Driving unit code

B or C

3. Controller function code

R: Standard type

4. Special type code

01 - 99 : Non standard specification.

5. Specification

5-1. Pump specification

Model	Disch. capacity (ml/min)	Max. disch. press. (MPa)	Stroke length mm (%)	Stroke rate (spm)	Connection hose size (mm)	Average power consumption (W)	Mass (kg)
EHN-B11	30	1.0	0.5-1.0 (50-100)	1-360	∅4×∅9	20	1.8
EHN-B16	55	0.7					
EHN-C16	65	1.0	0.5-1.25 (40-100)			24	2.9
EHN-C21	110	0.7					

- Note 1. The performance data is obtained by pumping clean water at ambient temp. at a rated voltage.
2. The values in a box of the maximum discharge capacity are the ones at max. discharge pressure (100% stroke length, 360 spm stroke rate). Pump discharges the liquid much more than the above value at the low discharge pressure.
3. Permissible ambient temperature : 0 - 40 deg. C.
4. Permissible liquid temperature : 0 - 40 deg. C.
5. Permissible voltage fluctuation : Within ±10% of the rated voltage

The specification may be changed without a prior notice.

Outline of product

5-2. Control unit

Operation mode	Mode	Manual
	Switching	EXT (Pulse dividing or multiply) Key operation
Stroke rate	Set range	1 - 360 spm
	Set method	Up or down key
	Memory function	By non-volatile memory
STOP input	When M - OFF	Pump stops when contact signal comes.
	When M - ON	Pump runs when contact signal comes.
	Input signal	Potential free contact or Open collector (Note 1)
EXT input	Upper limit stroke rate	Stroke rate indication of manual mode
	Pump operation	1 input signal : "n" pumping(s) (Pulse multiply) Note 2. "n" input signal(s) : 1 pumping (Pulse dividing) Note 3. *When "n" is 1, the pump starts synchronized operation
	Input signal	Potential free contact or open collector (Note 1.)
	Dividing ratio/Multiply ratio setting range	1-999 (Dividing or multiply)
Display	Figures	4 digits LCD
	Pump motion	Green LED (one) (Blinks synchronously with pump operation)
Power source voltage (Note 4.)		100-240VAC, 50/60Hz

Note 1. : Max. charged voltage to contact is 12V and 5mA current. If contact such as relay is used, its applicable load should be 5mA or below.

Note 2. : The input signals over the upper limit stroke rate are stored up to 255 signals.

Note 3. : The residual input signals over 360 spm are cancelled.

Note 4. : Do not apply any voltage other than the specified one. It causes the pump failure.

6. Operating function

6-1. Manual operation

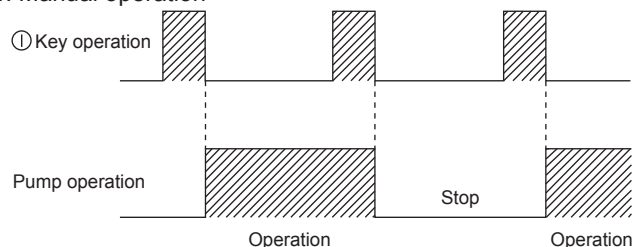

With ▲ (UP) and ▼ (DOWN) keys, set a stroke rate between 1 and 360 spm. Pushing ⓪ (Stop/start) key starts or stops pump. A stroke rate can be set regardless of whether a pump is running or not.

6-2. EXT operation

EXT input (Multiply) when the set number of pumping is 5

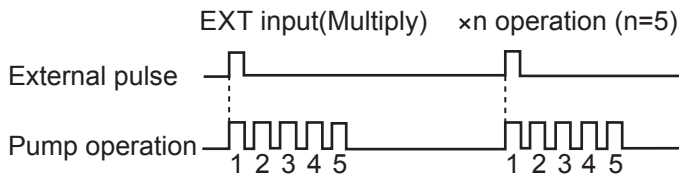

EXT input operation (Pulse multiply)

Pump operates with the set number of pumping between 1-999 for a external pulse signal. The preset stroke rate in the manual operation is applied as the upper limit stroke rate in the multiply operation. The pulse signals which come while pumping for the set number of times for a external pulse signal are cancelled but stored up to 255 pulses. When the number of pumping is set to 1, pump operates synchronously with a external pulse.

Outline of product

EXT input (Dividing) when a set number of pumping is 5

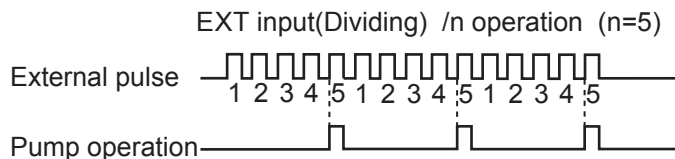

EXT input operation (Pulse dividing)

Pump makes a pumping for the external pulse signal. The preset stroke rate in manual operation is applied as the upper limit stroke rate in the dividing operation. The residual input signal over 360 spm are cancelled. When the number of external signals is set to 1, pump operates synchronously with an external pulse.



Caution

When the number of external pulse signals for a pumping is set to 1 in pulse dividing operation, pump operation can be unstable due to the residual signal cancellation function but it is not a malfunction of pump. Set the number of pumpings for the external pulse signal to 1 in the pulse multiply operation.

7. STOP function

7-1. At M – OF setting

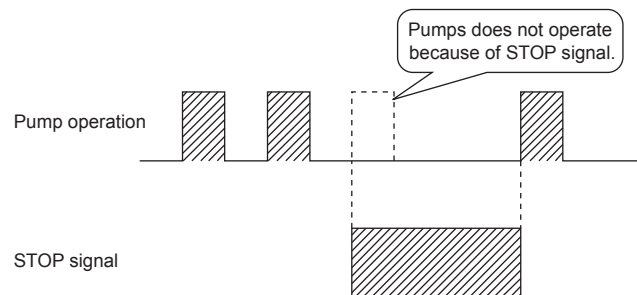

When the STOP signal comes (contact closed), stop pump.
When the STOP signal stops, pump operates.

7-2. At M – ON setting

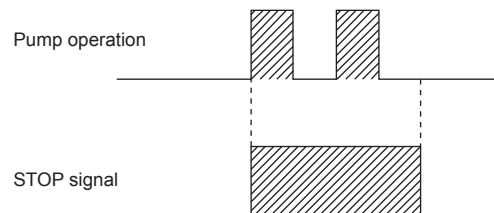

Pump operates while the STOP signal comes (contact closed). If the pump is in EXT operation mode, pump operates synchronously with the external signal only while the STOP signal is coming.

Outline of product

8. Overview

8-1. Overview of pump

Bleed port

Be sure to connect a tube and return a tube end to the suction side tank.

Adjusting screw

Control unit

For the pump operation, the flow rate adjustment and the stroke rate adjustment-setting.

Stroke length adjustment knob

Driving unit

Secure a pump installation to prevent the liquid from spilling on this part.

Nameplate

Use the pump according to the specification on nameplate.

Discharge port

Be sure to connect a tube and return a tube end to the suction side tank.

Pump head

Suction port

Base

Fix base with screws.

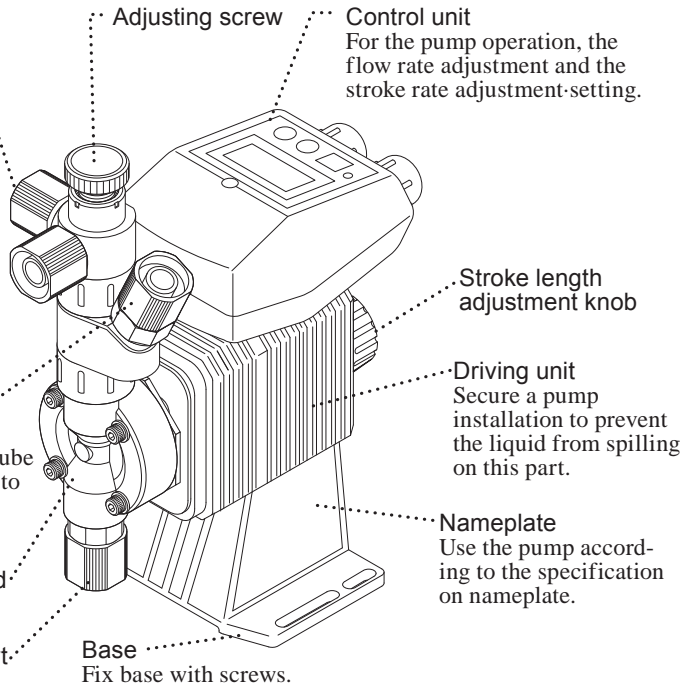

Outline of product

8-2. Overview of controller

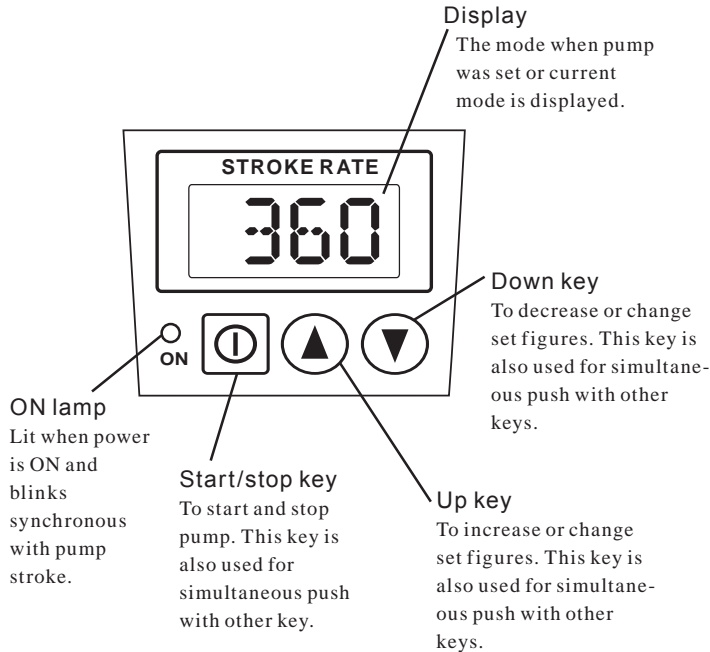

	ON lamp lights.	ON lamp blinks.
360	Waiting in manual operation mode.	Running in manual operation mode. The display blinks as well.
EXT	Waiting EXT input in EXT mode.	Running synchronously with EXT input in EXT mode.

8-3. Basic display.

	ON lamp lights.	ON lamp blinks.
STOP	STOP function is operating.	
-STOP	STOP function is operating in manual waiting mode.	
T-5	Chattering is being set. T-10 or T-50 may be displayed.	
/NNN	Pulse dividing is selected in the selection display.	
XNNN	Pulse multiply is selected in the selection display.	
/ 5	The dividing ratio of EXT mode is being set. The left display shows 1 pumping for 5 pulses.	
X 5	The multiply ratio of EXT mode is being set. The left display shows 5 pumping for a pulse.	
M-OF	STOP input is set. M-ON may be displayed.	
OVER	EXT input exceeds the pump upper limit spm in EXT mode. Pump operates at its upper limit spm.	EXT input is exceeding the pump upper limit spm in EXT mode. Pump is operating at its upper limit spm.
.360		Pump is running with pulse dividing/multiply operation for external input pulses. The indication shows pump operation spm.
Ⓛ-360 (Lock)	Key is locked. Key operations are ineffective in this state. Release the key lock function before operation.	Key is locked. Key operations are ineffective in this state. Release the key lock function before operation.

Installation

1. Before installation

"Strictly observe the following points."

Operators and maintenance service staff must read the instruction manual thoroughly before using the products. Do not operate the pump system unless all of the contents in the manual are completely understood.

Warning

- **Turn off the power supply**
Working without disconnecting the power supply may cause an electrical shock. Before engaging upon any working procedures involving the pump, make sure to turn the power supply switch off and to stop the pump and other related devices.
- **Terminate operation**
When you detect or become aware of a dangerous sign or abnormal condition during operation, terminate the operation immediately and start it from the beginning again.
- **Specified power only.**
Do not operate the pump on voltage which is not specified on the nameplate. Failure to do so may result in damage or fire. Only the specified power level is to be applied.
- **Keep from heat or flame.**
Do not place any dangerous materials or flammable objects near the pump for the prevention of fire or accident.
- **Damaged pump**
Never operate a damaged pump. A damaged pump may cause leakage or electrical shock.

2. Precaution on handling

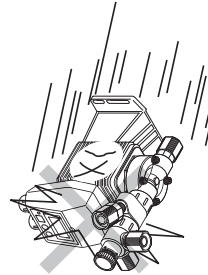

- Dropping the pump or subjecting it to strong impacts may result in faulty performance. Handle the pump with care.

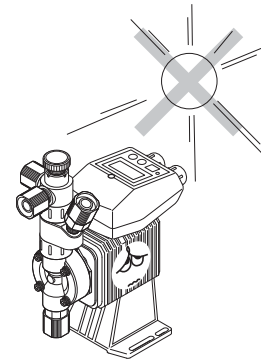

- When installing the pump, avoid places exposed to direct sunlight or direct rain with an ambient temperature of above 40 deg.C, or with a relative humidity of above 85%. Though the pump has a simple waterproof and dustproof structure, do not install it outdoor.
- Select an installation site convenient for future maintenance and inspection, and fix the pump on a level floor so that it is free of vibrations.

Installation

- **Ventilate.**

Poisoning may result during an operation which involves toxic or odorous liquid. Ventilate the operating site sufficiently.



- **Do not wet or dampen.**

If an electric part or wiring gets wet with the liquid spilled over accidentally, a fire or electrical shock may be caused. Install the system in a place free from liquid spillage or leakage.



Prohibited

- **Install an earth leakage breaker (option).**

The operation of a pump without using an earth leakage breaker may cause an electrical shock. Please purchase an optional leakage breaker and install in the system.

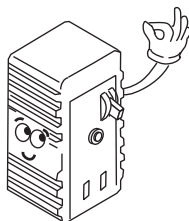

Prohibited

- **The control unit can be detached. However, it should not be detached unless unavoidable. Never use the detached control unit with the pump models other than the one delivered.**



Caution

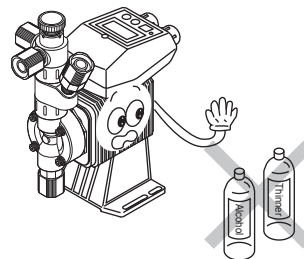

- **Arrange grounding.**

Do not operate the pump without connecting the grounding wire. Otherwise, an electrical shock may result. Make sure the grounding wire is connected with the grounding terminal.

- **Limited operating site and storage**

Do not install or store the pump in the following places:

- * Places where a flammable gas or material is used or stored.
- * Place where the ambient temperature is extremely high (40 deg.C or higher) or extremely low (0 deg.C or lower).

- **Cleaning**

Wiping the pump body or the nameplate with a cloth soaked in a solvent such as benzene, thinner or kerosene may remove or change the colour of the coating. Use a dry cloth or a cloth soaked in water or neutral detergent.

Installation

3. Installation

Caution

- When you detect or become aware of a dangerous sign or abnormal condition during operation, stop the operation and restart the procedure from the beginning.

• Installation

Install the pump at a site where the ambient temperature does not exceed 40 deg.C and the relative humidity does not exceed 85%. (There should be no dew condensation inside the control unit.) The site must be selected keeping in mind ease and efficiency for maintenance and inspection work.

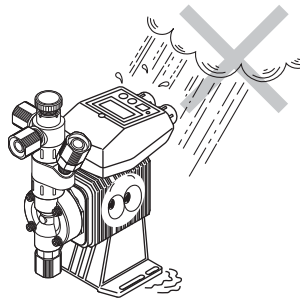

- Place the pump as close to the suction tank as possible, realizing a flooded suction system (where the pump is located lower than the suction-side tank).



Caution

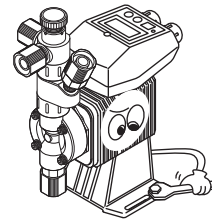

Side view of tube

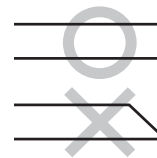

- If the pump is used to feed liquid that generates air bubbles easily (sodium hypochlorite, hydrazine solution, etc.), it must be positioned in a cool, dark place away from direct sunlight.

• Anchoring pump

Select a level floor free of liquid splash, and use M5 screws to firmly anchor the pump so as not to allow any vibration. If the pump is inclined, the discharge amount may be decreased considerably and may even reach the zero level.

• Preparation of tube

Before the installation of the pump, cut the ends of the tube flat.

Installation

4. Tubing

- Have the tubing short and straight in order to reduce the loss in pipe.
- Attached hoses should be connected to a discharge port, bleeding ports and a suction port. Be sure to secure the firm fitting for the prevention of the liquid leakage or the air suction.

Note

- Fitting nut is made by plastics. It may be broken if tightened excessively. Insert each tube to the bottom of a connecting port, first tighten a fitting nut by hand and then turn it by 180 degrees with a wrench.
- Use a chloroethene braided hose with a suitable bore. If the attached hose is not long enough.
- A part of liquid always comes out from the bleeding ports. Be sure to connect the attached bleed hose to every bleeding port and return the hose end to a suction tank (Fig. A and B).

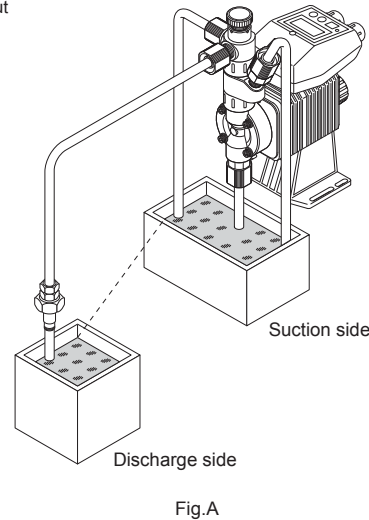
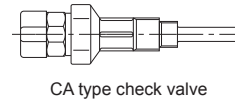
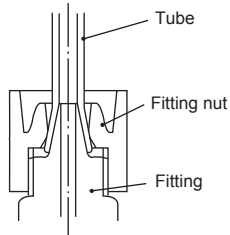

- Check valve mounting
A check valve is attached in order to avoid a over feeding. Be sure to install the check valve in the following condition.
 - a. In case the liquid level of suction side is higher than discharge side. (See Fig. A) When injection point is below the liquid level of suction side at atmospheric pressure.

Installation

b. In case the discharge side liquid level is higher than suction side liquid level within 5meter.



Caution

Some liquid bring about the congestion by crystal. Clean the inside of tubing or replace tubing periodically.

c. In case discharge side pressure is below 0.13MPa (pipe resistance or discharge head etc.) .

- Check valve should be installed at a tube end on the discharge side tubing, apart from 1 meter from pump.
- Threaded connection of R1/2 or R3/8 is also available to CA type check valve. Cut off an unnecessary part to use them.

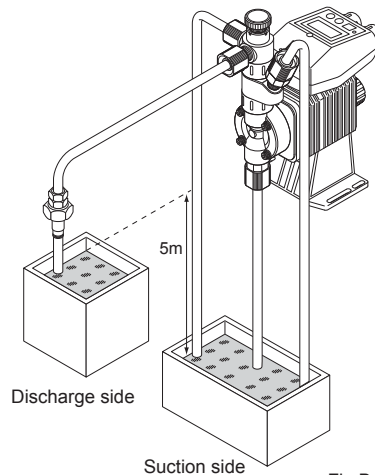
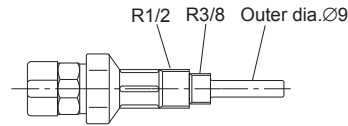

Fig.B



CA type check valve

d. In a flooded suction.



Caution

In a flooded suction, the length of suction pipe should be within 1m.

When sucking liquid under a flooded suction through a long pipe over 1m, a check valve may not work.

After an operation after a long period of storage, loose an adjusting screw to eliminate air. In order to prevent air from coming in the inside of hose.

Installation

5. Electrical wiring

Caution

Electrical works and handling of power source must be done by qualified person. Otherwise injury or damage may happen.

5-1. Wiring of power source

- Before works confirm that main power source is turned off.
- Wiring must be done according to your electrical works standard using good wiring equipment/device.

Caution

Power voltage must be charged at a sitting via switch or relay. Otherwise malfunction of CPU may happen.



When power is charged at a setting



When power is charged gradually

For the relay to be used, refer to P17 which mentions the precaution when pump is controlled by relay ON/OFF.

Secure wire connection by the crimp contacts at the end of power cord

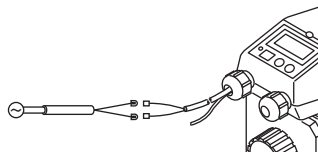

Caution

Never put other voltage than rated voltage. Otherwise electronic circuit may be broken.

- Be sure to connect ground wire.
- Do not use a plug socket for the pump together with a high power equipment which may generate surge voltage. Otherwise electronic circuit may be failed. Pay attention to the noise generated by inverter or so.

Installation

- Surge voltage



Caution

Electronic circuit of control unit may be failed by extremely large surge voltage. Do not use the pump near to the high power equipment of 200V or more which may generate large surge voltage. If use of high power equipment is inevitable, take any of the following measures.

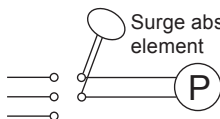

a. Install a surge absorption element (Varister or so of 2000A or more durability) at pump power connection part.

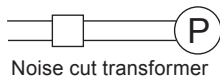

b. Install a noise cut transformer.

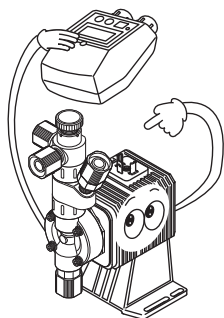

5) Control unit can be removed easily from pump driving unit. Never mount the controller once removed from the different model of pump. Otherwise electronic circuit or driving unit may be damaged.

- Precaution when pump power is turned ON and OFF by relay.



Caution

Control unit is equipped with CPU. It is recommended to stop pump through STOP input terminal but not by switching ON/OFF of power source because switching ON and OFF of power may cause malfunction of CPU. When the use of ON/OFF of power can not be avoided, pay attention to following points.

In case power is ON and OFF by relay, its contact volume must be 5A or more. If relay of 5A or below is used, the contact point may be welded.

If the relay of contact point volume 5A is used for EHN, it can be used for max. 150 thousands times ON and OFF. If you expect more than 150 thousands times or if same power source as large capacity equipment is used, the contact may be welded by surge voltage. In this case use the relay of contact volume of 10A or more. If you will be suffering from durability of relay, use non contact transistor relay (ex. G3F made by OMRON or so). For details refer to catalogue or other documents of equipment manufacturer.

Installation

5-2. Wiring of the external input signal



Caution

Never connect wires while power is turned on. Otherwise you may be electrically shocked or controller may be short-circuited. Turn off power when wiring works are done.



Caution

Do the works one minute after the power is turned off because electricity is charged inside pump just after the power is turned off.

External signal

EXT function : Stroke rate can be controlled by the pulse signal.

STOP function : Pump can be ON and OFF by the external signal.

Use either one of the no voltage contact signal or open collector signal for the external signal. In case of the pulse signal is used, pulse width should be 10 ms to 100 ms with pulse rate of 360 pulses/minute or below.



Caution

• Wiring of EXT and STOP

Do not combine cable of EXT and STOP with power cord. Do not combine power source, the EXT signal wire and the STOP signal wire by concentric cable (5 wires cable or so). Otherwise noise is generated in EXT, STOP wires caused by induction effect from power cable, which results in wrong operation or failure of pump.

• When using SSR (solid state relay) for the EXT/STOP signal input

When using SSR for the EXT/STOP signal input, use the recommended products stated below. SSR which is other than recommended can cause malfunction.

1. G3FD-102 S or G3FD-102SN made by OMRON
2. G3TA-IDZR02S or G3TA-IDZR02SM

Refer to information materials such as catalogue of manufacturer for further information.

• When using type device for the EXT/STOP signal input

When using type device such as relay for the EXT/STOP signal input, select some device of which minimum application load is 5mA or below.

Installation

- Wiring procedure

 Caution

Used cord must be 7.8 mm of outer diameter. If other diameter of cord is used, perfect connection or sealing can not be obtained, which may result in a malfunction of electronic circuit.

- 1) Remove a gasket (A) on top of the control unit and then remove screw (B), gasket (C) and two screws (D) at the end of the stroke length adjusting knob to remove the control unit.
- 2) Remove four screws (E) at the bottom of control unit to remove controller cover.
- 3) Remove a cord nut (F) for signal cord and remove a protective cap (G). The cap (G) is not used when cord is connected. Pull a cord gasket (J) out of controller unit.
- 4) Insert an external signal cord through the cord nut (F) and the cord gasket (J) into the control unit.

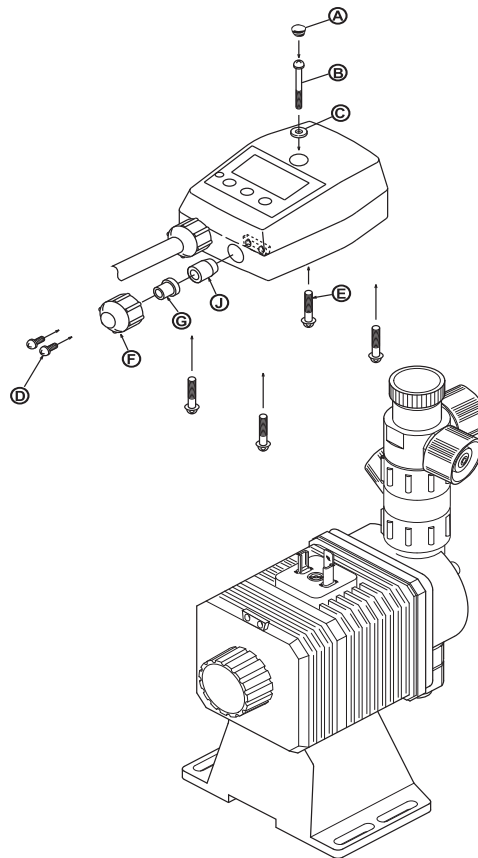

Installation

5) Remove a plug (H) from a socket (I). Connect signal cord to the plug (H) with a screw driver and mount it on the socket (I). Pull the signal cord to adjust the slack inside the control unit and then mount the cord nut (F) securely by hand. (The cord is sealed by cord gasket (J).)

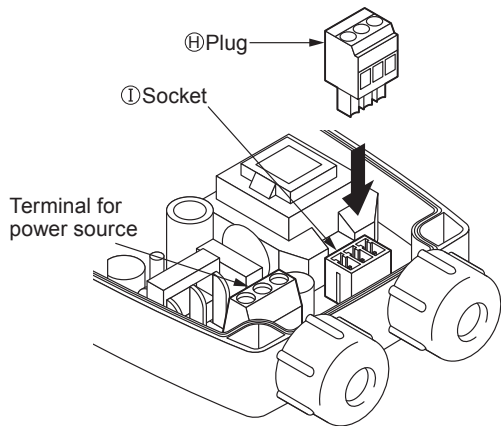

6) Mount control cover and mount the controller in the reverse procedure of above items 1) and 2).

Tightening torque of each screw is as follows:

Screw B : 0.39N.m

Screw D : 0.4N.m

Screw E : 0.8N.m



Caution

Do not forget to mount gaskets A and C. Without them, liquid may get into controller and controller may be failed.

Wiring to socket (I) for signal input

Potential free contact signal

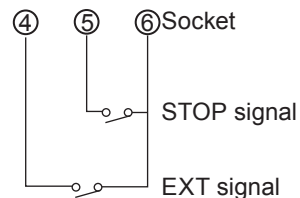

Open collector signal

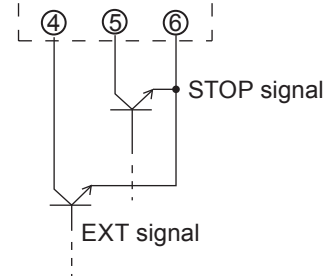

Operation

1. Operation

After the installation, piping, and wiring processes are completed, operate the pump in accordance with the following steps.

Caution

- Do not operate pump with a completely closed discharge-side valve.
Operating the pump with the discharge-side valve fully closed may lead to liquid leakage or pipe rupture. Make sure not to operate the pump with the discharge-side valve closed.

- Do not run pump dry.

A pump which has been run dry may experience liquid leakage during its liquid feeding operation. Make it a rule to run the pump after supplying liquid inside the pump.

Note: Dry operation of the pump over a long time (longer than 30 minutes) causes the pump to overheat and the pump unit (pump head, valve case, etc.) to become deformed or the pump head attachment to become loose, which may result in liquid leakage trouble.

- Re-tighten bolts of pump head

Loosened bolts on pump head may cause liquid leakage. To avoid liquid leakage caused by loosened bolts, periodically tighten four hex. sock. cap. bolts in diagonal order.

Note: Also at the time of the initial operation, tighten the four hex. sock. cap. bolts diagonally because the bolts may be loosened during the storage or transit.

Tightening torque

Model	Torque	Remarks
EHN-B11 • B16 • C16 • C21	2.16N • m	M4 hex. socket head bolts

To start and stop pump

- 1) Turn on power.

Turn on power and ON lamp (green) lights to come to waiting mode in manual mode. (When power is turned on initially.) Display shows stroke rate.

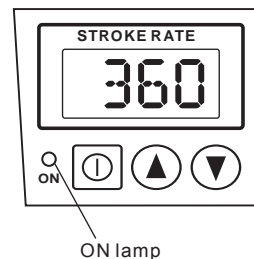

- 2) Push  key once and pump starts operation and both ON lamp and stroke rate indication blink synchronously with pump stroke.

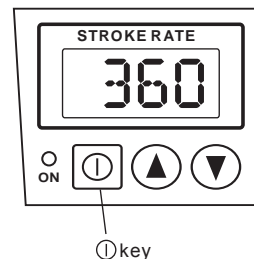

Operation

1-1. Bleeding

Bleeding is a process undertaken to eliminate air inside the suction-side tube and the pump head. Make sure to carry out bleeding prior to the initial operation of the pump and/or after replacing the liquid in the tank. For safe bleeding, first set a pipe to the air-vent port of the air vent unit.



Caution

Some liquids used in pump may cause skin trouble or affect the quality of a mechanical part. Wipe off the liquid immediately when it wets the hand or a mechanical part.

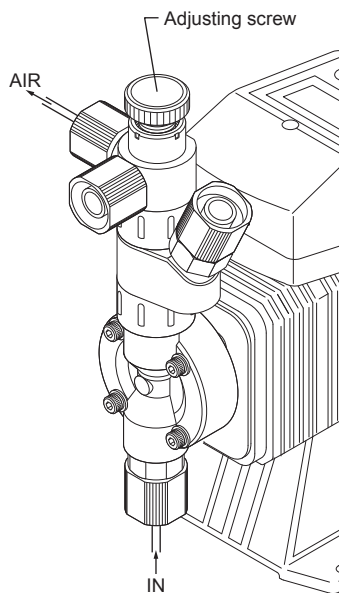

Bleeding procedure

- 1) Start pump. A lamp blinks to indicate pump is operating.
- 2) Adjust the pump stroke rate to 360 spm.
- 3) Turn the adjusting screw to the left by 180 degrees to open a bleed port.
- 4) After running pump for 10 minutes or more, make a bleeding.
- 5) Turn the bleed adjusting screw to the right to close bleed port.
- 6) Check no liquid leaks from any connections.

1-2. Adjustment of discharge capacity

Adjustment of discharge capacity can be done by stroke rate adjustment or by stroke length adjustment but basically it is done by adjusting stroke rate. Adjustment by stroke length is auxiliary way to cover the range which is not obtained by stroke rate adjustment.

Precaution for stroke rate adjustment

- a. When pumping gaseous liquid such as sodium hypochlorite (NaOCl) and hydrazine solution ($\text{N}_2\text{H}_2\text{O}_2$), stroke length must be 100% or near adjusting stroke rate. Discharge capacity may be reduced when stroke length is short.
- b. When back pressure at discharge side is high, set stroke length to 100% or so adjusting capacity by stroke rate.
- c. In case the discharge capacity per shot greatly influences the reaction in neutralization or titration application, adjust to short stroke length to reduce capacity per shot and adjust it by stroke rate.

Operation

- Procedure to adjust discharge capacity
Suitable stroke length and stroke rate are decided considering pump operating condition and liquid characteristics etc. Following procedure is recommended.

- Set stroke length at 100% and roughly adjust discharge capacity by stroke rate adjustment.
- Measure discharged volume.
- If measured volume is less than required volume then increase stroke rate to measure again discharged volume.
- Do fine adjustment of discharge capacity by adjusting stroke length.
- Measure again the discharged volume to confirm the required volume is obtained.

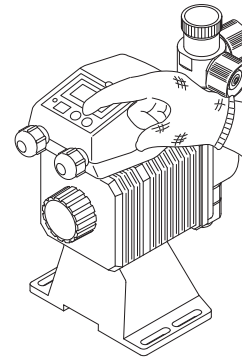
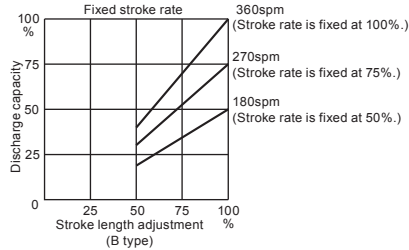

- Adjustment of stroke rate
Setting of stroke rate is done by UP and DOWN keys.
Stroke rate per minute of plunger is controlled in the range of 1 to 360 spm.

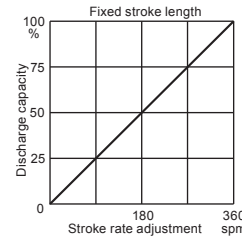

Operation

Caution

Never turn stroke length adjusting knob while pump stops.

- Stroke length adjustment
Stroke length is adjusted by changing the returning distance of plunger.
- a. Turn on power and adjust discharge capacity by stroke length adjusting knob while pump is running.
- b. Figure on right shows the relation between discharge capacity and stroke length.
Discharge capacity shows by percent (Discharge capacity shown on nameplate is 100%).
- Stroke length can be adjusted from 0 to 100% but actually adjust it in the range of 50 to 100%.

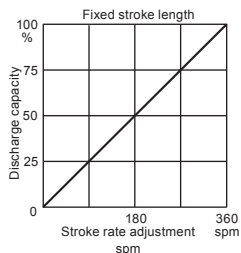
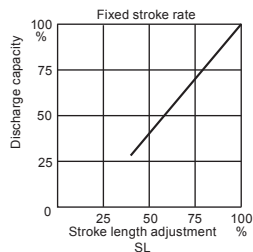
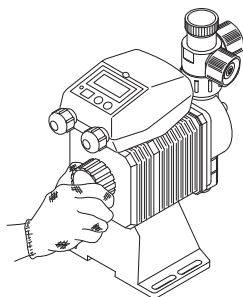

1-3. Precaution when pump is stopped

- In case pump is stopped for a long time (more than one month), operate pump with clean water for 30 minutes to clean wet-end of pump and piping.
- In case start pump again after a long time stoppage, clean valve set if pump does not suck up liquid when pump started. Remove adhered matters if you find them. Remove air if it remains in pump head and re-adjust discharge capacity. (Refer to pages 22 to 23.)
- To stop pump, stop it by key operation before turning off power. Power must be turned off three seconds or after pump is stopped. If power is turned off within three seconds, the key operation of pump stoppage may not be put in memory. In this case pump operates when power is turned on again and liquid is discharged.

Operation

2. Operation of controller

Pump control can be done by operating control unit. Read this chapter thoroughly to correctly operate pump in each operating mode.

The figure on right shows the operation diagram of control unit.

2-1. Control unit operation diagram

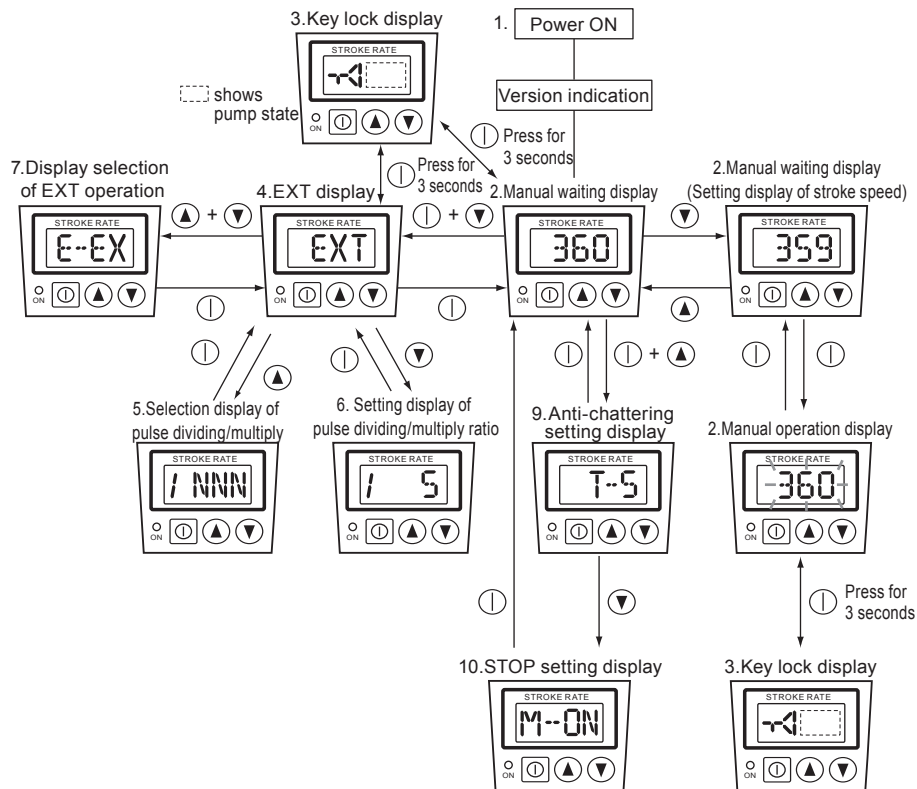

Operation

- 1) When the pump is powered for the first time, built-in program version is shown and then manual waiting mode appears. When pump is powered on and after the second time, pump starts with the status of when pump was turned off last time.
- 2) In manual waiting mode, push start/stop key ① to start pump. If the key is pushed again, pump stops and moves to manual waiting mode.
- 3) When pressing ① key for 3 seconds in manual waiting or EXT waiting mode or during manual operation, Key lock function can be active. In this state all the key operations are ineffective. Release the key lock function by pressing ① key for 3 seconds again.

- 4) EXT mode is to operate pump by the external signal.

In manual waiting mode, push ④ key as pressing ① key to move to EXT mode. To stop pump, push ① key to move to manual waiting mode.

- 5) To select pulse dividing or pulse multiply, push ④ key in EXT mode to move to the selection display of pulse dividing/pulse multiply.
- 6) To change the pulse dividing/pulse multiply ratio, Push ④ key in EXT mode to move to the setting display of pulse dividing/pulse multiply ratio.
- 7) To display spm indication of EXT operation, push ④ key while pushing ④ key in EXT mode to move to the display selection mode of EXT operation.
- 8) Setting of anti-chattering and STOP function are used in order to change the factory setting value.
- 9) To change the setting of anti-chattering, push ④ key as pressing ① key to move to anti-chattering setting display. Push ④ key to set and push ① key to confirm it and return to manual waiting mode.

- 10) To change STOP setting, first push ④ key as pressing ① key in manual waiting mode to move to anti-chattering setting display. And then push ④ key once to move to STOP setting display. Push ④ key to select M-ON or M-OFF and push ① key to confirm it and move to manual waiting mode.

For details, refer to Control unit setting/operation procedure.



Caution

Pushing ① key stores the revised setting on a memory. Do not turn off power before pushing ① key. The revised setting is not stored.

2-2. Parameter

Mode	Parameter	Factory set	Set range	Step
Manual	Stroke rate (spm) (Note 1)	360	1 - 360	1 (Note 2)
	Anti-chattering (Note 3)	T-5	T-5/T-10/T-50	—
	STOP (Note 4)	M-OFF	M-OFF/M-ON	—
EXT	Selection of pulse dividing/multiply	/NNN	/NNN, XNNN	—
	Dividing ratio	1	1-999	1 (Note 2)
	Multiply ratio	1	1-999	1 (Note 2)
	Display selection mode	EX	EX/SP	—

- Note 1. This value is used as the upper limit stroke rate of EXT mode as well.
2. One push changes one stroke. When keeping up or down key pressed, figure changes continuously.
 3. The larger the value is, the stronger against disruption of input pulse it becomes, however, it gets harder for pump to detect pulses if ON time gets shorter. The value is approx. time (msec) for pump to detect pulse. Set the ON time of input pulse larger than chattering value.
 4. If M-ON is selected, pump starts operation upon returning to manual waiting if the STOP signal is inputted. Pay attention each time of changing setting.

Operation

2-3. Setting and operation of control unit

2-3-1. Manual operation

1) Turn on power

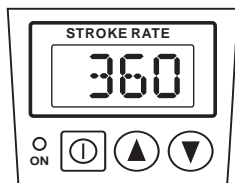

When power is turned on for the first time, program version is shown briefly and manual waiting mode appears. On and after the second time pump is turned on, display shows the mode of when power was turned off last time.



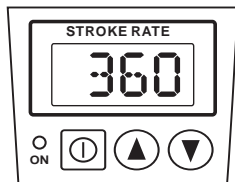



2) Go to manual mode

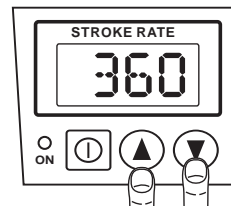

In case stroke rate (1 - 360) is not shown on display, move to manual mode with key operation. Push  key when EXT is shown on display. STOP or -STOP indication means STOP function is active. Release STOP function. Refer to page 35 to release STOP function.



3) Set stroke rate

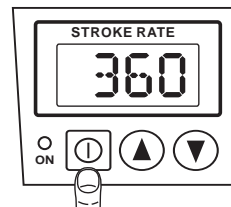

Change stroke rate shown on display by  or  key. If either  or  key is pushed continuously for more than 3 seconds, stroke rate changes quickly. If the key is continuously pressed, the increment or decrement stops when it reaches 360 or 1. To skip from 360 to 1 (or 1 to 360) release the key once and then push  (or ) key once.

4) Start/stop of pump



Push  key once to start pump and then ON lamp and spm indication blink. Push  key again to stop pump and ON lamp lights. (When stroke rate is slow, ON lamp blinks longer.)

Operation

2-3-2. EXT operation

1) Turn on power

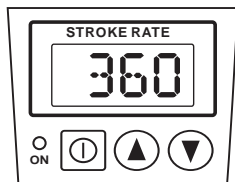

When pump is turned on for the first time, program version is shown briefly and then manual waiting mode appears. On and after the second times, EXT is shown on display if power was turned off last time while pump was in EXT mode.

In case STOP or –STOP is shown, release STOP function because STOP function is active. Refer to page 35 to release STOP function.

2) Set upper limit stroke rate of EXT

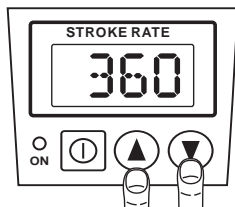

If pump is in manual mode, stop pump and set stroke rate. If pump is in EXT operation mode, push ⓐ key to move to manual waiting mode and set stroke rate.

3) Set EXT operation mode

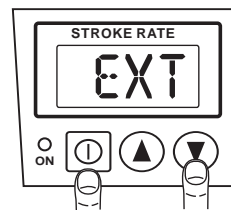

In manual waiting mode push ▼ key as pressing ⓐ key to move to EXT mode. As soon as pump is in EXT operation mode, pump runs synchronously with EXT input.

4) Return to manual mode

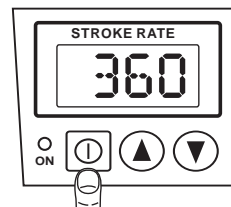

Push ⓐ key once to return to manual waiting mode. Stroke rate appears on display.

⚠ Caution

When pump is in EXT operation mode, the maximum number of strokes is equal to the number of strokes displayed in manual operation mode.

For example: When the number of strokes displayed in manual operation mode is 200 spm, the maximum number of strokes in EXT mode is 200 spm and pump operates at 200 spm or below even if the pulse signal come to operate pump at 360 spm.

Operation

2-3-3. Key lock function

1) Keypad lock active modes.

Manual waiting mode

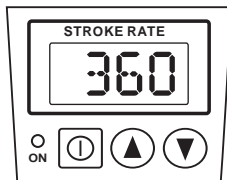

or

During manual operation

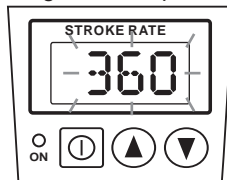

EXT mode

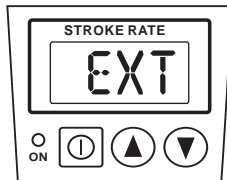

or

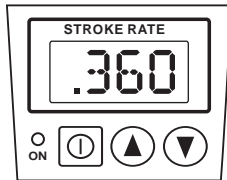

Display one of those modes for locking keypads operation.

2) To have Key lock function active.

During manual operation

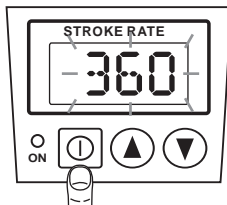

Press  key for 3 seconds when one of the above modes for keypad lock is displayed.

During manual operation or EXT mode.

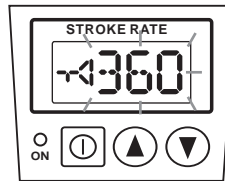

Manual waiting mode

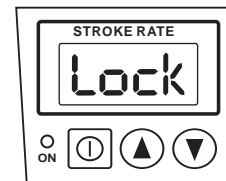

A key mark is indicated during manual operation or EXT mode and keypad operations become ineffective. Lock indication is displayed in manual waiting mode.

3) To release Key lock function.

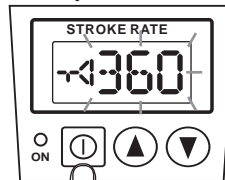

During manual operation with keypad locked

Press  key for 3 seconds when key pad is locked. Key mark disappears and keypad operations become effective.

Caution

All the keypad operations are ineffective when the keypads are locked. Turn off main power source if it is necessary to stop the pump urgently. When turning on power again, the pump restarts with the keypads locked.

And pressing  key for 3 seconds when pumping by the stop signal also have the key lock function active, however; the indication is STOP or -STOP. If STOP function is released, the indication changes into that of key lock function.

Operation

2-3-4. Selection of pulse dividing/pulse multiply

1) Turn on power

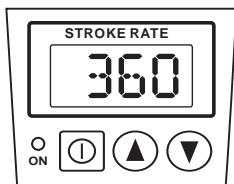

When power is turned on for the first time, program version is shown briefly and manual waiting mode appears. On and after the second time pump is turned on, pump restarts with EXT operation mode and EXT indication appears on the display if the pump was in EXT operation mode when turning off power last time. If STOP or -STOP indication is displayed, STOP function is active. First, release STOP function. Refer to page 35 for how to release STOP function.

2) Move to EXT mode

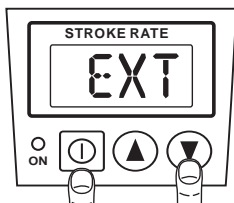

Push \downarrow key as pressing \uparrow key in manual waiting mode to move to EXT mode. Do not input the signal at this phase.

3) Move to the selection display of pulse dividing/pulse multiply

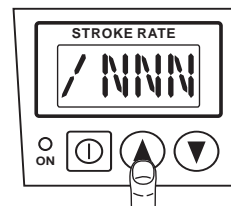

Push \uparrow key to move to the selection display of pulse dividing/pulse multiply.

4) Select pulse dividing or pulse multiply.

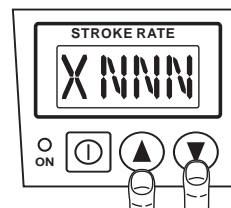

Push \uparrow or \downarrow key to select pulse dividing or pulse multiply in the selection display.

Operation

5) Return to EXT mode.

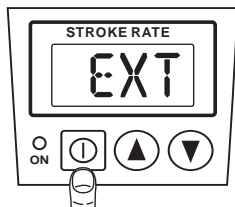

Push ⓪ key to move to EXT mode.

2-3-5. Setting of dividing ratio and multiply ratio

1) Turn on power

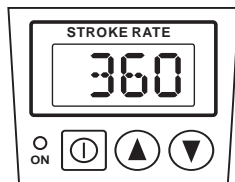

When power is turned on for the first time, program version is shown briefly and manual waiting mode appears. On and after the second time pump is turned on, pump restarts with EXT operation mode and EXT indication appears on the display if the pump was in EXT operation mode when turning off power last time. If STOP or -STOP indication is displayed, STOP function is active. First, release STOP function. Refer to P.35 for how to release STOP function.

2) Move to EXT mode

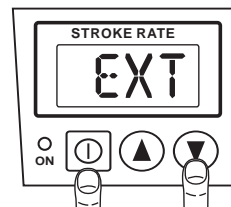

Push ▼ key as pressing ⓪ key in manual waiting mode to move to EXT mode. Do not input the signal at this phase.

3) Move to the setting display of dividing ratio and multiply ratio.

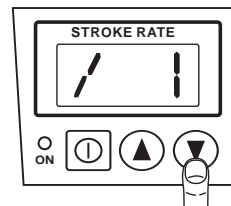

Push ▼ key once to move to the setting display of dividing ratio and multiply ratio.

Operation

4) Set the dividing ratio or multiply ratio

Use \blacktriangle or \blacktriangledown key to set the dividing or multiply ratio in the setting display.

- Multiply or dividing ratio changes one by one every time \blacktriangle or \blacktriangledown key is pushed.
- If either \blacktriangle or \blacktriangledown key is pushed continuously for more than 3 seconds, the ratio changes quickly. The increment or decrement stops when it reaches 999 or 1. To skip from 999 to 1 (or 1 to 999), release the key once and then push \blacktriangle (or \blacktriangledown) key again.

When dividing operation is selected.

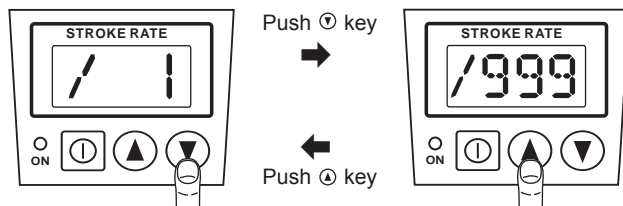

When multiply operation is selected.

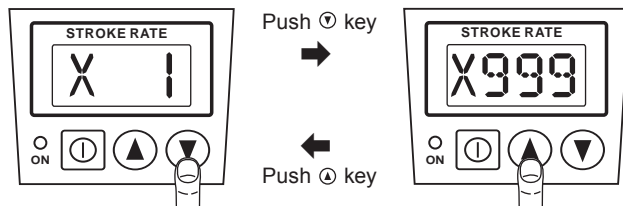

5) Return to EXT mode

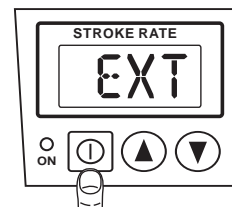

Push ⏻ key to return to EXT mode.

2-3-6. Display selection mode of EXT operation

1) Turn on power

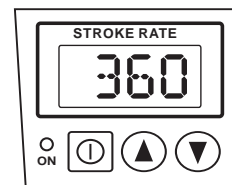

When power is turned on for the first time, program version is shown briefly and manual waiting mode appears. On and after the second time pump is turned on, pump restarts with EXT operation mode and EXT indication appears on the display if the pump was in EXT operation mode when turning off power last time. If STOP or -STOP indication is displayed, STOP function is active. First, release STOP function. Refer to P.36 for how to release STOP function.

Operation

2) Move to EXT mode

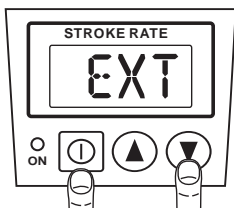

Push \downarrow key as pressing \uparrow in manual waiting mode to move to EXT mode. Do not input the signal at this phase.

4) Select EXT indication or spm indication

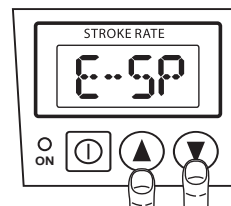

Use \uparrow or \downarrow key to select EXT indication or spm indication in the display selection mode of EXT operation.

3) Move to the display selection mode of EXT operation

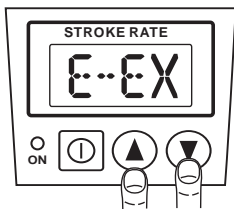

Push \downarrow key while pressing \uparrow key to move to the display selection mode of EXT operation.

5) Return to EXT mode

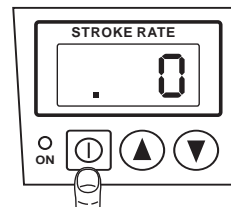

Push \uparrow key to return to EXT mode. The above display shows when spm indication is selected.



Caution

The spm indication on the display via the display selection reflects the actual pump rotation speed. It does not reflect the speed of the incoming external signal.

Operation

2-3-7. Setting of anti-chattering value

1) Go to manual waiting mode

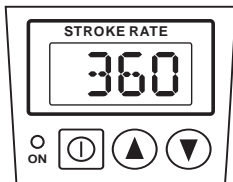

If pump is EXT mode, push  key. If STOP or -STOP is shown, release STOP function because STOP function is active. Refer to page 35 to release STOP function.

2) Set anti-chattering value

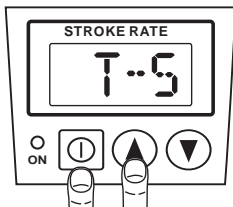

In manual waiting mode, push  key as pressing  key in order to indicate T-5 (factory setting) on display.

3) Change anti-chattering value

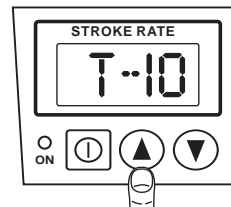

Push  key to change T-5, T-10 or T-50.

4) Fix the setting and return to manual waiting mode.

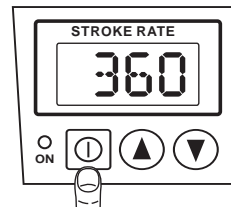

After the setting of anti-chattering value, push  key to confirm the setting and return to manual waiting mode. When pump is used together with pump controller 50 series, set anti-chattering to T-5. Pump may not operate if it is set to T-10 or T-50.

Operation

2-3-8. Setting of STOP function

1) Go to manual waiting mode

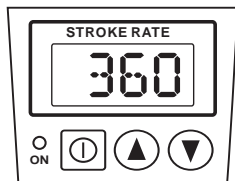

If pump is in EXT mode, push ⓪ key. STOP or -STOP indication means STOP function is active. Release STOP function. Refer to page 35 to release STOP function.

2) Go to anti-chattering setting display

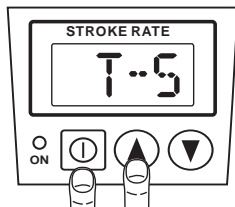

In manual waiting mode, push ⓪ and ⬆ keys simultaneously to show T-5 (factory setting) on display.

3) Go to STOP setting display

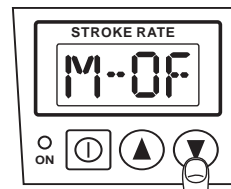

Push ⬇ key once to show either M-OF (factory setting) or M-ON on display.

4) Change STOP setting

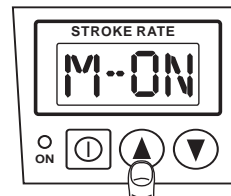

Push ⬆ key to select M-OF or M-ON.

5) Fix STOP setting and return to manual waiting mode.

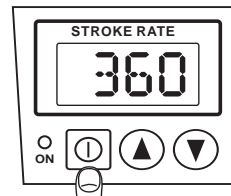

Push ⓪ key to fix setting and return to manual waiting mode.

 **Caution**
M-ON: Pump starts to run when the STOP signal is inputted.
M-OFF: Pump stops running when the STOP signal is inputted.

Operation

2-3-9. Setting of STOP function

1) Move to the waiting mode of STOP function.

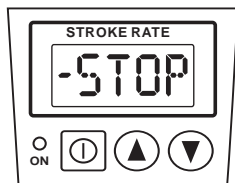

If display shows "STOP", push ON key to stop pump operation. When -STOP indication appears, push Δ key while pressing ON key to move to anch-chattering setting.

2) Move to anti-chattering setting display.

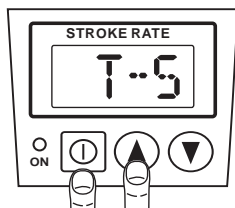

When -STOP indication appears, push Δ key while pressing ON key. Display shows "T-5" "T-10" or "T-50".

3) Move to STOP setting display.

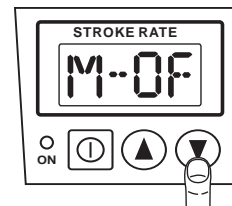

Push ∇ key once. Display shows "M-OFF" or "M-ON". STOP function can be released by changing this setting.

4) Change current STOP setting.

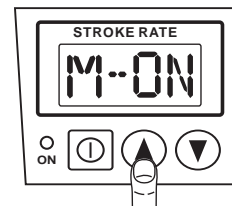

Push Δ to select "M-OFF" or "M-ON".

5) Confirm new STOP setting and return to manual mode

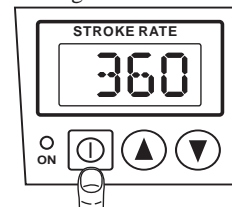

Push ON key to confirm new setting. Pump enter to waiting mode and STOP function is released.

Maintenance

Maintenance, inspection, disassembling and assembling should be done according to this instruction manual. Do not handle the pump beyond the instruction shown on this manual.

Warning

• Wear protector

You may be injured by chemical or toxic liquid if they are splashed or you touch them. Wear protector such as protective mask, safety globe or so when the works are done.



• Turn off power

You may be electrically shocked if you do the works while power is turned on. When you do the works be sure to turn off power of pump or other equipment. When you stop pump, it should be stopped by key operation before you turn off power. Power must be turned off at least three seconds after pump is stopped by key operation. If power is turned off within three seconds, pump stopping operation may not be put in memory. If this happens, pump starts when power is turned on again and chemical may be discharged.



1. Troubleshooting

Trouble	Cause	Troubleshooting
Pump does not start.	<ul style="list-style-type: none"> ● Faulty wiring or disconnection in wiring ● Lowered voltage ● Electronic circuit of control unit is damaged. 	<ul style="list-style-type: none"> ○ Correct wiring. ○ Trace cause and raise voltage to specified level. ○ Replace the whole unit.
Liquid suction cannot be done.	<ul style="list-style-type: none"> ● Air suction in suction piping ● Valve gasket is not installed. ● Valve set assembling direction is wrong. ● Pump is air-locked. ● Pump stroke length is too short. ● Suction-side/discharge-side valve is clogged with foreign matter. ● Adhesion of valve onto valve seat 	<ul style="list-style-type: none"> ○ Set piping normally. ○ Install valve gasket. ○ Reassemble valve set. ○ Carry out air elimination. ○ Drive pump with stroke length set at 100%. Then, reset stroke length. ○ Disassemble, inspect, and clean. ○ Disassemble, inspect, and clean.
Discharge amount fluctuates.	<ul style="list-style-type: none"> ● Suction-side/discharge-side valve is clogged with foreign matter. ● Air is trapped in pump. ● Overfeeding ● Diaphragm is damaged. 	<ul style="list-style-type: none"> ○ Disassemble, inspect, and clean. ○ Carry out air elimination. ○ Install check valve. ○ Replace diaphragm.
Liquid leaks.	<ul style="list-style-type: none"> ● Valve or connecting port is not tightly closed. ● Pump head is not tightly closed. ● Diaphragm is damaged. ● O ring and valve gasket are not installed. 	<ul style="list-style-type: none"> ○ Tighten section. ○ Tighten pump head. Torque: 2.16 N·m ○ Replace diaphragm. ○ Install O ring and valve gasket.

Maintenance

Troubleshooting for the automatic air vent

Trouble	Cause	Troubleshooting
Liquid suction cannot be done.	<ul style="list-style-type: none"> ● Pump is air-locked. ● Air vent valve set is clogged with foreign matters or crystals. 	<ul style="list-style-type: none"> ○ Carry out air elimination manually. ○ Disassemble, inspect, and clean.
Liquid leaks.	<ul style="list-style-type: none"> ● The fixation of a discharge port, a bleeding port and a fitting adapter is loose. ● The fixation of connecting ports are loose. ● O rings or gaskets are not installed. 	<ul style="list-style-type: none"> ○ Tighten loose fitting. ○ Tighten loose fitting. ○ Install O rings or gaskets.
Excessive elimination form a bleeding port	<ul style="list-style-type: none"> ● Air vent valve set is clogged with foreign matter or crystal. 	<ul style="list-style-type: none"> ○ Disassemble, inspect, and clean.

2. Maintenance and inspection

Pay attention to the following points during pump operation. Stop pump immediately if you find abnormality and take measures according to the item "Troubleshooting". When wear parts come to the life time, replace them by new ones. (Refer to the item "Wear parts".

No.	Check Point	Description	How to Check
1	Does pump lift liquid normally?	<ul style="list-style-type: none"> • Is liquid normally fed? • Is suction pressure/discharge pressure at normal level? • Has liquid undergone quality change, crystallization, or solidification? 	<ul style="list-style-type: none"> • By flow meter or visual inspection • Check nameplate. • By visual and audio inspection
2	Abnormal noise or vibration?	<ul style="list-style-type: none"> • Abnormal noise or vibration may result from abnormal functioning of pump. 	<ul style="list-style-type: none"> • By visual and audio inspection
3	Is there liquid leakage or air suction at any joint on pump or piping?	<ul style="list-style-type: none"> • Tighten joint where leakage has occurred. • Excessive air bubbles in discharged liquid mean air suction has been caused in system. Examine the piping and tighten joint which leaks. 	<ul style="list-style-type: none"> • By visual inspection

! Check to see periodically if pump head mounting bolts are not loosened, and tighten them by diagonal order if necessary. Pump head mounting bolts may be loosened during pump operation.



Tightening torque of pump head mounting screw



Model	Torque	Remarks
EHN-B11 • B16 • C16 • C21	2.16N m	M4 hex. sock. cap. bolt

Maintenance

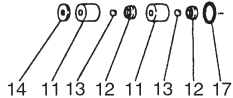
3. Wear parts

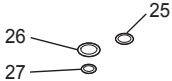
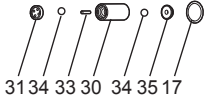
If pump is to be used for a long period, wear parts should be replaced in proper period. It is recommended that the following parts are always ready for the replacement. Contact us for further information.

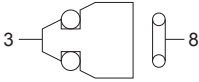
	Parts	Q'ty	Time to be replaced
Pump head		2 sets	8000 hours
		1	
		Refer to Exploded view	
		1 set	

	Parts	Q'ty	Time to be replaced
Check valve		1	8000 hours
		1	

Note: Durability of wear parts depend on pumped liquid, temperature and pressure.

Time to be replaced mentioned as above is the estimation obtained by continuous pumping of clean water at ambient temperature.

Maintenance

4. Disassembling and assembling

Warning

- **Wear protector**

You may be injured by chemical or toxic liquid if they are splashed or you touch them. Wear protector such as protective mask, safety globe or so when the works are done.



Wear protective gear

- **Turn off power**

You may be electrically shocked if you do the works while power is turned on. When you do the works be sure to turn off power of pump or other equipment. When you stop pump, it should be stopped by key operation before you turn off power. Power must be turned off at least three seconds after pump is stopped by key operation. If power is turned off within three seconds, pump stopping operation may not be put in memory. If this happens, pump starts when power is turned on again and chemical may be discharged.



- **Release the pressure inside pump and discharge hose prior to loosening the piping connections or dismantlement of pump. Dismantlement with pressure inside pump could lead to liquid eruption.**



- **Pay attention not to touch residual liquid when dismantling pump.**



Caution

Method to release pressure:

- 1) Stop pump
- 2) Turn bleed adjusting screw to left by two turns to fully open bleed port.
- 3) Confirm liquid goes out from bleed port and pressure was released.

Caution : If liquid does not go out, the pressure may be kept inside.

In this case operate pump in this condition to discharge liquid bleed port and confirm the pressure is released.

EHN-30-35 types (excluding PP type) are not equipped with bleed valve. For these types install an bleed valve at discharge piping to release valve.

Before works

- When pump is disassembled, pay attention to the liquid which may remain inside pump.
- Wash wet-end of pump head.

Works

- When pump head is disassembled, replace diaphragm, O ring, valve gasket and valve set by new ones.

Caution

- Pump is not water-proof construction.
- If liquid is splashed on pump (driving unit, control unit, pump head), they may be failed and accident may occur. Do not splash liquid on them. If splashed, wipe them off with cloth.

Maintenance

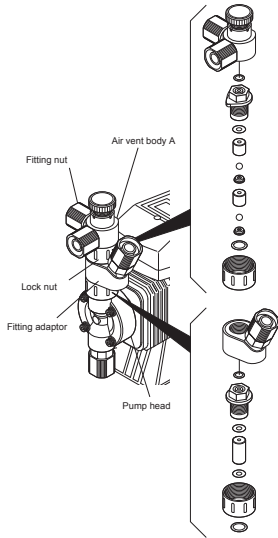

4-1. Valve assembly

■ Disassembly of discharge valve

1. The removal of the discharge side valve set
 - a. Loosen a fitting nut and remove hose fitting. Take care not to spill liquid.



Caution

Some liquids used in pump may cause a skin trouble or affect the quality of a mechanical part. Wipe off the liquid immediately when it wets the hand or a mechanical part.

- b. Turn a lock nut anticlockwise to remove Air vent body A.
 - c. Remove air vent body B with a spanner. Detach valve seats from fitting adaptor.

Maintenance

■ Disassembly of suction valve

- Loose a fitting nut to remove hose fitting. Take care not to spill liquid.
- Loose a fitting with a spanner and remove it.
- Detach valve set and check inclusions. In case the inclusions are scratched or worn-out, replace them with new ones.

The tightening torque of the fitting and the air vent valve body B is 3.43N•m.

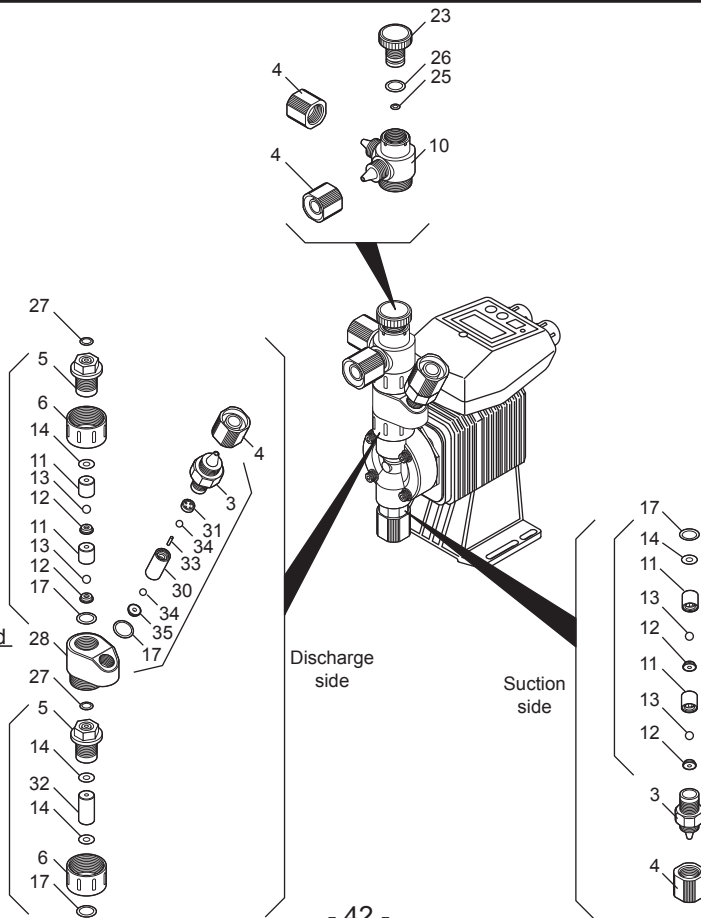

■ Assembly

Assembly is done in reverse order of disassembly. Pay attention to the following.

- Pay attention to the arrangement of valve set. Wrong arrangement and direction will cause a failed pumping (liquid leakage, decreased discharge capacity).
- Be sure to mount O rings and gaskets.

1) Mount a discharge side valve set

- Put a valve set in a fitting adaptor and screw it in air vent body B through a lock nut.
- While holding a fitting adaptor, turn a lock nut clockwise to tighten it. Then re-tighten it by 90 degrees with a spanner.

2) Mount a suction side valve set

- Put a valve set in a fitting and screw the fitting in a pump head by hand. Then re-tighten it by 90 degrees with a spanner.

Maintenance

- Replacement of air vent valve set
- Dismantlement

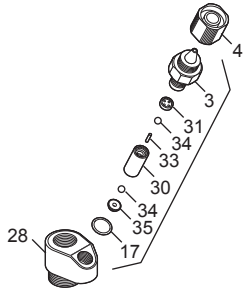

Air vent valve set removal

- Loose a fitting nut on the air vent valve set to disconnect a hose, taking care not to spill liquid.
- Turn a fitting anticlockwise to detach it with a spanner.
- Take the automatic air vent valve set out from the fitting adapter.

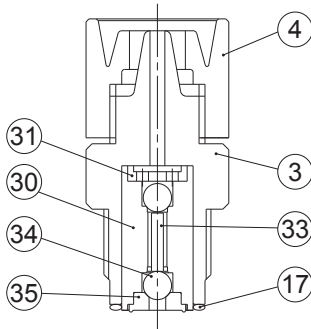

Automatic air vent valve assembly drawing

- Assembly

Slot the air vent valve set in the fitting and screw the fitting in the fitting adapter by the hand. Tighten the fitting nut by a spanner by 90 degrees in the last place.

When slotting the air vent valve set in the fitting, make sure the concave surface of the AV guide ③③ faces up.

Tightening torque of the fitting of the automatic air vent is 2.45N·m.

Maintenance

■ Replacement of diaphragm

● Dismantlement

a. Loosen the 4 hex. sock. cap. bolts by a hexagon head bar to remove the pump head from pump body.

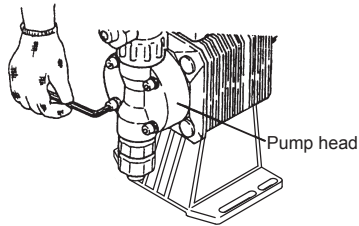

b. Hole the outer edge of the diaphragm and turn the diaphragm anticlockwise in order to detach it from a plunger.

● The diaphragm spacers beside a retainer are for the diaphragm positioning. If the diaphragm spacers are attached, be careful not to loose them.

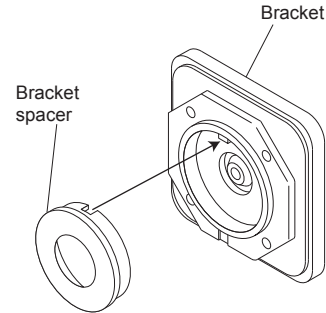
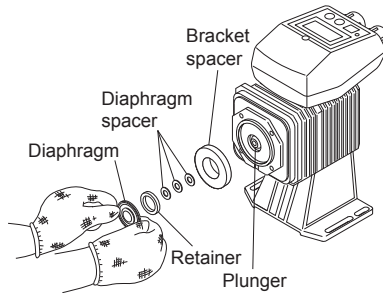

● Assembly

Assembly procedure is in reverse order of dismantlement. Pay attention to the following points.

a. The first step for assembling the pump head is to set the stroke length at 100%.

● Start the pump to have the plunger length fully prominent and stop it. Be sure to turn off power after the setting.

b. Insert a retainer, diaphragm spacers to the thread of diaphragm and screw the diaphragm in the plunger.

● Fit the concave surface of the retainer to the convex surface of the diaphragm face to face. Be careful not to let them come off .

c. Fix the pump head to the pump body. Tighten the 4 hex. sock. cap. bolts equally.

● Tightening torque :
2 .16N•cm

Exploded view

Components are completely disassembled to quick review. The extent of disassembling is limited to the instructions shown on the maintenance section.

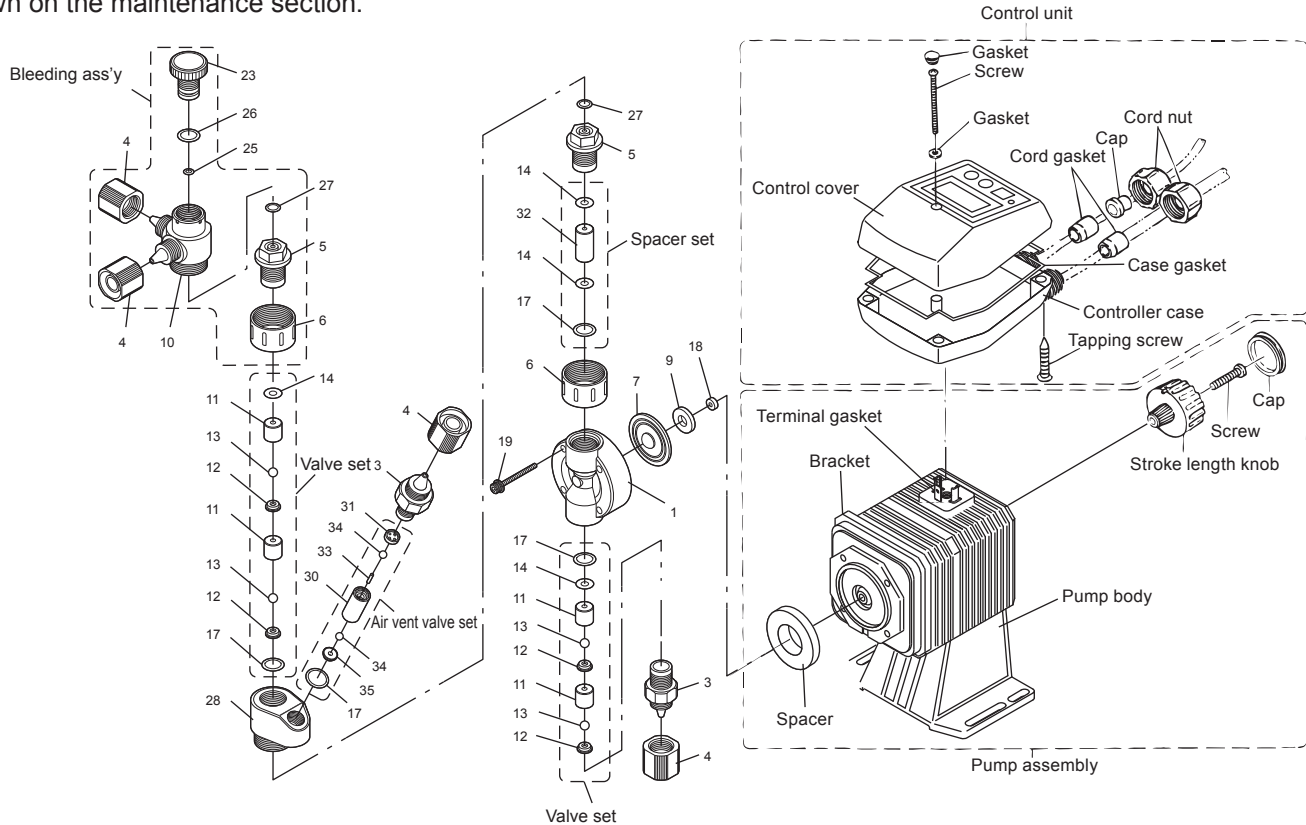

Exploded view

■ Pump head

● EHN-B10 B15 C20

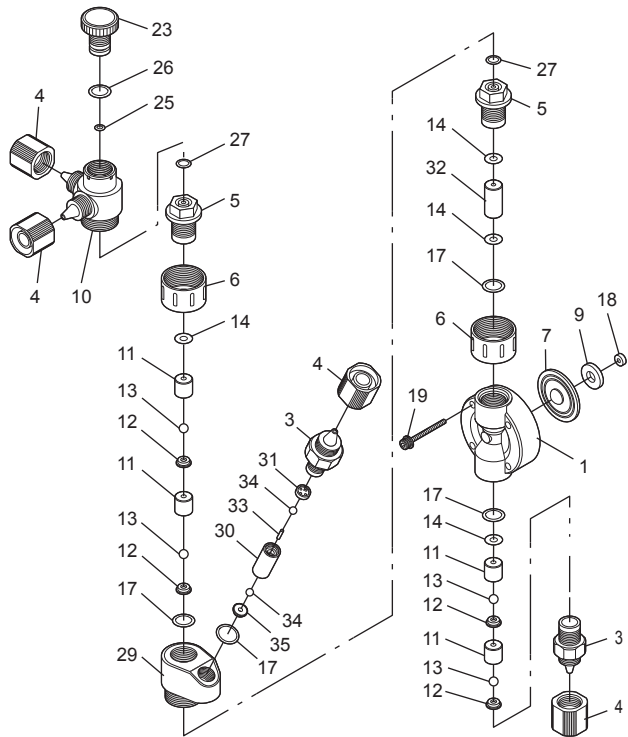

No.	Parts name	Q'ty
1	Pump head	1
3	Fitting	2
4	Fitting nut	4
5	Air vent body B	2
6	Lock nut	2
7	Diaphragm	1
9	Retainer	1
10	Air vent body A	1
11	Valve guide	4
12	Valve seat	4
13	Valve	4
14	Valve gasket	4
17	O ring	4
18	Diaphragm spacer	
19	Hex. socket head bolt	4
23	Adjusting screw	1
25	O ring	1
26	O ring	1
27	O ring	2
29	Fitting adapter	1
30	Air vent valve guide A	1
31	Air vent valve guide B	1
32	Spacer	1
33	Separate pin	1
34	Valve	2
35	Valve seal	1

Exploded view

■ Check valve

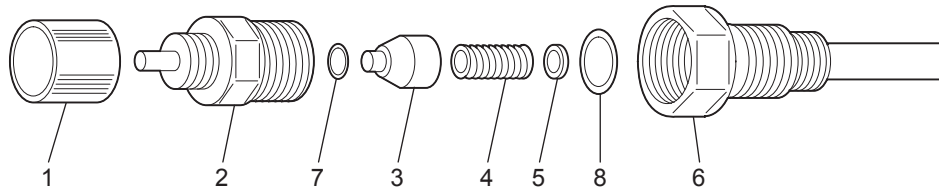

No.	Parts name	Q'ty
1	Fitting nut	1
2	Valve case	1
3	Poppet	1
4	Spring	1
5	Spacer	1
6	Valve fitting A	1
7	O ring	1
8	O ring	1

Outline dimension

• EHN-B11•B16(NAE)

• EHN-C16•C21(NAE)

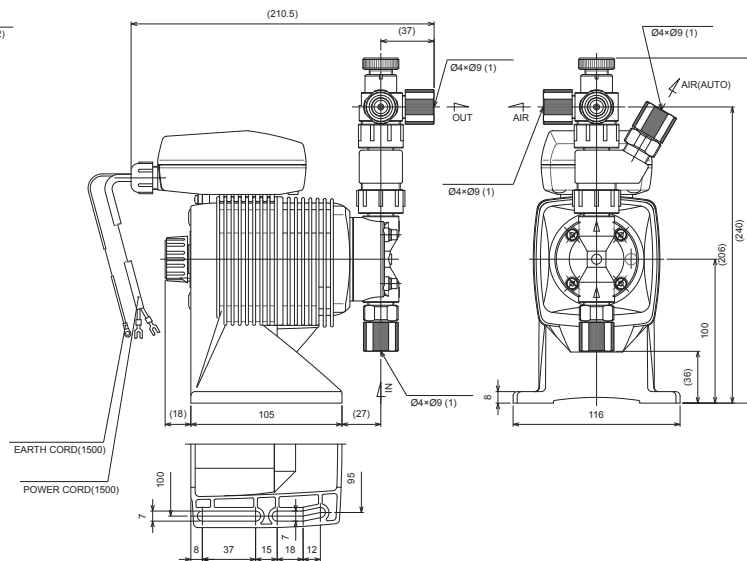
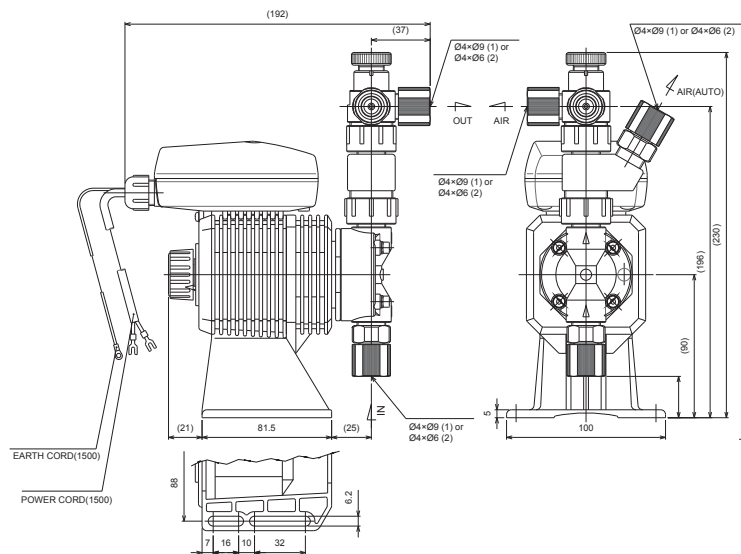



IWAKI CO.,LTD. 6-6 Kanda-Sudacho 2-chome Chiyoda-ku Tokyo 101-8558 Japan

TEL: (81)3 3254 2935 FAX: 3 3252 8892 (<http://www.iwakipumps.jp>)

()Country codes

U.S.A. : IWAKI America Incorporated	TEL : (1)508 429 1440	FAX : 508 429 1386	Germany : IWAKI EUROPE GmbH	TEL : (49)2154 9254 0	FAX : 2154 1028
Australia : IWAKI Pumps Australia Pty. Ltd.	TEL : (61)2 9899 2411	FAX : 2 9899 2421	Italy : IWAKI Italia S.R.L.	TEL : (39)02 990 3931	FAX : 02 990 42888
Singapore : IWAKI Singapore Pte. Ltd.	TEL : (65)6316 2028	FAX : 6316 3221	Denmark : IWAKI Nordic A/S	TEL : (45)48 24 2345	FAX : 48 24 2346
Indonesia : IWAKI Singapore (Indonesia Branch)	TEL : (62)21 690 6606	FAX : 21 690 6612	Sweden : IWAKI Sverige AB	TEL : (46)8 511 72900	FAX : 8 511 72922
Malaysia : IWAKIm Sdn. Bhd.	TEL : (60)3 7803 8807	FAX : 3 7803 4800	Finland : IWAKI Suomi Oy	TEL : (358)9 2742714	FAX : 9 2742715
Taiwan : IWAKI Pumps Taiwan Co., Ltd.	TEL : (886)2 8227 6900	FAX : 2 8227 6818	Norway : IWAKI Norge AS	TEL : (47)66 81 16 60	FAX : 66 81 16 61
Thailand : IWAKI (Thailand) Co.,Ltd.	TEL : (66)2 322 2471	FAX : 2 322 2477	France : IWAKI France S.A.	TEL : (33)1 69 63 33 70	FAX : 1 64 49 92 73
Hong Kong : IWAKI Pumps Co., Ltd.	TEL : (852)2 607 1168	FAX : 2 607 1000	U.K. : IWAKI PUMPS (UK) LTD.	TEL : (44)1743 231363	FAX : 1743 366507
China : IWAKI Pumps (Guandong) Co., Ltd.	TEL : (86)750 380 9018	FAX : 750 380 9078	Switzerland : IWAKI (Schweiz) AG	TEL : (41)26 674 9300	FAX : 26 674 9302
China : GFTZ IWAKI Engineering & Trading (Guangzhou)	TEL : (86)20 8435 0603	FAX : 20 8435 9181	Austria : IWAKI (Austria) GmbH	TEL : (43)2236 33469	FAX : 2236 33469
China : IWAKI Pumps Co., Ltd. (Beijing)	TEL : (86)10 6442 7713	FAX : 10 6442 7712	Holland : IWAKI Holland B.V.	TEL : (31)297 241121	FAX : 297 273902
China : IWAKI Pumps (Shanghai) Co., Ltd.	TEL : (86)21 6272 7502	FAX : 21 6272 6929	Spain : IWAKI Iberica Pumps, S.A.	TEL : (34)943 630030	FAX : 943 628799
Philippines : IWAKI Chemical Pumps Philippines, Inc.	TEL : (63)2 888 0245	FAX : 2 843 3096	Belgium : IWAKI Belgium n.v.	TEL : (32)1367 0200	FAX : 1367 2030
Korea : IWAKI Korea Co.,Ltd.	TEL : (82)2 3474 0523	FAX : 2 3474 0221			
Vietnam : IWAKI Pumps Vietnam Joint Venture Co.,Ltd.	TEL : (84)613 933456	FAX : 613 933399			