

**Applicable to the Many
Diverse Needs of Chemical
Feeding**



Suitable for Many Chemical Liquid Feeding

IWAKI's systematic LK series metering pump consists of the worm gear type dual-cam driving section, which is compact yet rigid and reliable, and wet-end materials of which there are seven types for various applications.

With long and market-proven experience, IWAKI has employed state-of-the-art pump technologies in the development of an ideal type of chemical feeding pump which has advantages such as quality, performance, ease of operation and cost efficiency. The LK series is suitable for many chemical liquid feeding processes used in a wide range of fields, including water treatment, chemicals, fabrics, paper mill, food processing, and medicine.





Various Types and Materials

Nine types (IWAKI original motor) and eight general purpose motor types are available to suit each user's needs in accordance with feeding rate from small to large capacity. Also, material variation has been improved. Selection of the pump material most suitable for the applied liquid is possible with seven different types available.



High Performance and Application-Oriented Versatile Design

Discharge accuracy (stability) is within $\pm 2\%$ FS. Reliability is considerably enhanced through efforts to improve the linearity of the stroke / discharge ratio as well as the dispersion between stroke. Three types of joints flange, hose and union joints are standardized for the connections. The optimum piping system can be selected. (Only with 0.2kW IWAKI original motor type)



LK-B75S4



LK-B65VC



LK-C86VC

Construction

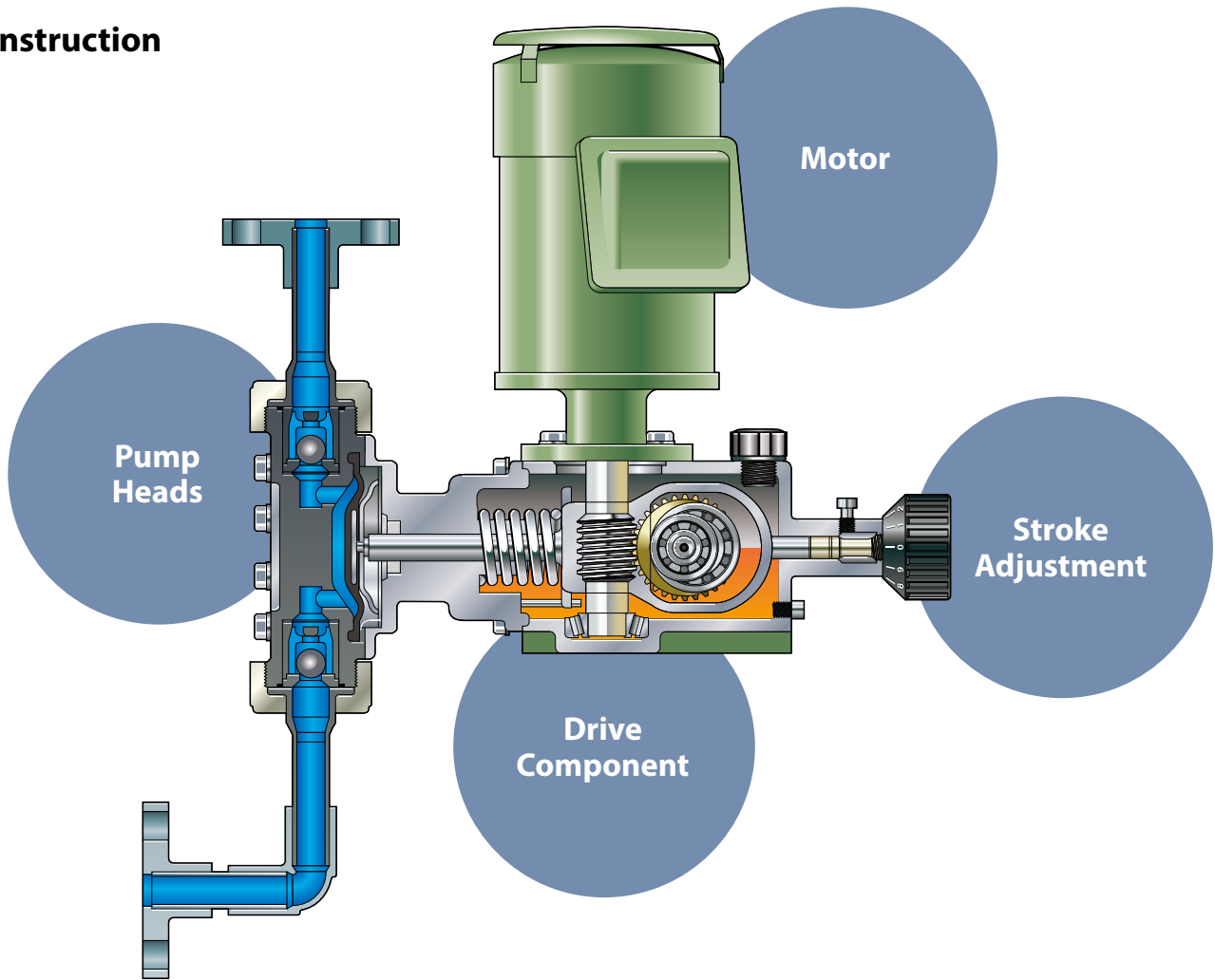

Pump Heads

Drive from the gear reduction unit is directly transmitted to the diaphragm. This type of metering pump is economical and simple with a high degree of versatility. With the employment of moulded PVC pump-head, and with the new standardisation of three types of connections using flanges, hose, or union joints (0.2kW type), not only a saving in parts cost but also improved flexibility of installation has been realized. The three main pump head materials are PVC, stainless steel, or fluororesin. The most suitable type for the application can be selected from a total of seven different materials. A wide range of chemicals, such as acid, alkali, organic solvent, slurry, and high-temperature liquids, is covered by the series.

• Please contact us for Model PVDF.

Drive Component

The head of the LK series is the dual-cam system driving section with a highly reliable, built-in worm gear type speed reducer. The compact and rigid mechanism is a result of the design goal to achieve maximum wear resistance in continuous operation. In addition to the worm gear which is designed with a considerably large module ratio, the material is aluminium bronze, and a taper roller bearing is used at the end of the worm gear for the efficient transmission of motor power to the pump section. A fully enclosed oil bath lubrication system is employed to permit outdoor installation. The durability in continuous operation over a long period of time is also excellent.



Motor

All of the standard models employ totally enclosed outdoor-use motors which are vertically mounted to save space. The 0.2kW type is an IWAKI original motor, which is installed in the small models of the LK series. Besides the standard 200V, other voltages are available. The LK series pumps of LK-F, LK-A, LK-B, and LK-C can be installed with general-purpose motors, including those for different voltage levels and explosion-proof specifications. Body configurations of the LK series are available in five types. They are an IWAKI original motor type frame and the general-purpose motor type frames, F, A, B and C.

Stroke Adjustment

Accurate and reliable stroke setting is possible with the micrometer type dial of the springback type stroke adjustment mechanism. An electric servo unit for automatic process control, such as flow, pressure, pH, temperature, and concentration can be arranged according to the user's needs.

Electric Servo System Specifications

- Input signal : DC4 - 20mA (or 1 - 5V)
- Power source : AC100V 50/60Hz; other voltage types available Voltage fluctuation 10%
- Motor output : LK (0.2kW) 15W LK-A, B, C 40W

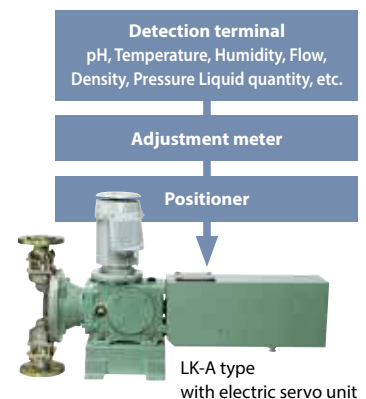

Pump Identification

2 LK - A 65 VC H - 04 F E S

1 2 3 4 5 6 7 8 9 10

- 1** Simplex / Duplex
LK (IWAKI original motor type)
 None : Simplex
2 : Duplex (special drive section:LK-11 to 47)
LK-F/A/B/C (JEM or IEC motor type)
 None : Simplex
 - 2** Series name
L series : Mechanical driven diaphragm type
 - 3** Drive section
LK (IWAKI original motor type)
 None : IWAKI original motor type 0.2kW / 0.25kW
LK-F/A/B/C (JEM or IEC motor type)
F : 0.25 or 0.37 kW (for IEC), 0.4kW
A : 0.4kW
B : 0.75kW
C : 1.5kW
 - 4** Type No.
 First digit : Diaphragm (pump head size)
 Second digit : Speed-reducing gear ratio
1•5 : 1/30, **2•7** : 1/15, **6** : 1/20
 - 5** Material symbol
 Refer to the material table
 (Ex. **VC, V6, VS4, VS, S6, S4**)
 - 6** Joint
 None : Flange
U : union (LK-11 to LK-57)
H : hose (LK-11 to LK-47)
 - 7** Motor output
LK (IWAKI original motor type)
02 : 0.2kW, **03** : 0.25kW (single phase)
LK-F/A/B/C (JEM or IEC motor type)
04 : 0.4kW, **07** : 0.75kW, **15** : 1.5kW
 - 8** Special motor
LK-F/A/B/C (JEM or IEC motor type)
F : Inverter motor
 (Note : General-purpose motors have no explosion-proof symbol.)
 - 9** Servo unit
E : With electric servo unit
 - 10** Special symbol
S : Special specification other than standard.
- This table dose not introduce the standard combination. Please contact us for details.
 • In case of pump without motor installation, the above item 7 and 8 are not indicated.

Materials

LK-11 to LK-57 (Flange type)

LK-A55 to LK-C87 (Flange type)

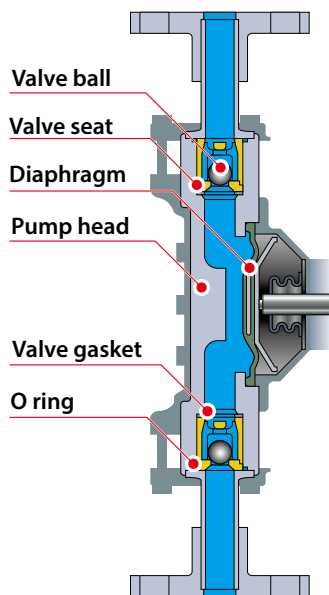
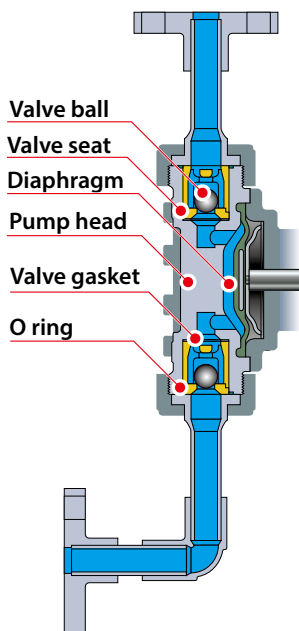

Typical chemical

VC: Sulfuric acid, Hydrochloric acid, Sodium hypochlorite
V6, VS4: Caustic soda, Coagulant. Calcium hydroxide (low density)
VS: Calcium hydroxide, High-molecular coagulant
S6, S4: Organic solvent, Paper making chemicals

Material symbols

SCS13: Stainless-cast steel equivalent to SUS304
CE: Alumina Ceramic
FKM: Fluoro rubber
EPDM: Ethylene propylene rubber

Type	VC	VCR	V6	V6R	VS4	VS4R	VS	VSR	S6	S4
Application	Acid		Alkali				Viscosity and Slurry		Solvent	
Applicable type	11 to 57 B75 to C87	A55 to B65	11 to 57	A5	B75 to C87	A65 to B65	11 to 57 B75 to C87	A55 to B65	11 to A57	A65 to C87
1: Pump head	PVC								SUS316	SCS13
2: Valve ball	CE		SUS316 equivalent		SUS304 ^{Note1}		SUS316 equivalent ^{Note2}		SUS304	
3: Valve seat	Type11 to 32	FKM		EPDM		PVC		SUS304		SUS316
	Type45 to 87			PVC				SUS304		SUS316
4: O ring	FKM				EPDM				-	
5: Valve gasket					PTFE					
6: Diaphragm					PTFE + EPDM					

Note1: Materials of the VS type valve balls are SUS316 equivalent for 11 to 57 type. As for the connection, which is different in some models from standard.

Note2: Materials of A65 to B65 is SUS304.

• A stainless steel pump SE type for latex emulsion is available (LK-31 to 57 type).
 • Material PVDF is also available. Please contact us for details.

Specifications

Model	Capacity ^{Note1} L/min		Max. Pressure ^{Note2} MPa		Stroke speed spm		Effective diaphragm dia. Ømm	Max. Stroke length mm	Connection ^{Note3}			Motor output kW ^{Note4}	Approx. ^{Note5} net weight kg			
	50Hz	60Hz	PVC	SUS	50Hz	60Hz			Flange (JIN10K)	Union	Hose Ømm		PVC	SUS		
LK- 11	0.020	0.024	1.0	1.5	48	58	22	1.5	15A (PVC) JIS16K (SUS)	VP16 (PVC)	4 x 9 (PVC) 12 x 18 (PVC)	0.2 (Three phase) or 0.25 (Single phase)	12	14		
21	0.050	0.060					96	116							30	2.0
22	0.10	0.12													48	58
31	0.25	0.30			96	116	72	6.0								
32	0.50	0.60													48	58
45	0.85	1.00			96	116	25A	VP25 (PVC)								
47	1.7	2.0													0.8	96
55	2.8	3.3			0.5	48	58	63							80	
57	6.0	7.2			0.3	96	116									79
LK- A55	2.8	3.3	1.0	48	58	100	10	25A	-	-	0.4	100	100			
A57	6.0	7.2	0.7	96	116	138	17.5	40A	-	-						
A65	9.0	10.8	0.3	48	58	138	17.5	40A	-	-	0.75	105	105			
B65	9.0	10.8	0.5	0.7	48	58	150	20	50A	-				-		
B75	13.3	16.0	0.5	72							86	150	20		50A	-
C76	20	24	0.3	96	116	205	20	65A	-	-						
C86	33	40									140	155				
C87	45	54														

Note 1: The capacity is the value when maximum discharge pressure is applied (with pure water at room temperature). The value may be larger than indicated in the table if the discharge pressure is lower. As for the liquid conditions pumped and performance. Refer to the technical information of this catalogue.

Note 2: The maximum discharge pressure of LK-A models are restricted to 0.7MPa for A55, 0.5MPa for A57 and 0.2MPa for A65 when IEC standard 0.37kW motor is adopted.

Note 3: VS type connection is different in some models from standard.

Note 4: The LK type is equipped with IWAKI original flange motor. The standard is 200V 3-phase, totally enclosed fan-cooled outdoor type. Other motors for different voltages, explosion-proof motors, or single-phase motors are available. LK-F, LK-A, B and C are to be installed with general purpose flange motors.

Note 5: The weight is the value when installed with a totally enclosed fan-cooled outdoor motor.

• Standard accessory : A siphon preventing valve, strainer and 4m PVC tube are furnished to hose connection type of simplex LK-11 to LK-45 VC A base is furnished to all LK-A, LK-B and LK-C models. For LK-(F) 11 to LK-(F) 57 models, the base may be supplied optionally.

• Coating color : F37-60D (JPMA) (However, the motors for LK-F/A/B/C use the maker's standard color.)

• Duplex type : LK-11 to 47 type include duplex types with a special-use integrated drive section.

Points to Be Observed in Pump Installation and Piping

IWAKI metering pump LK series are reciprocating pumps employing the eccentric cam system.

Reciprocating pumps generate pulsation in the suction and discharge piping. Special consideration, (different from the ordinary centrifugal pumps), should be given to this point when planning the pump installation and piping.

• Prevention of pipe vibration

Discharge side inertial resistance $P_{id} < 0.1\text{MPa}$

- P_{id} : Inertial resistance on discharge side

Inertial resistance means the pulsated impact force generated by the flow just upon entering discharge stroke. It is a phenomenon particular to a reciprocating pump which is generated as a result of the sudden application of acceleration to the liquid in the discharge piping. The condition " $P_{id} < 0.1\text{MPa}$ " is given above as an approximate standard. If P_{id} becomes 0.1MPa or higher, vibration on the pipe is generated. So measures should be taken to cope with the influence of vibration on the pump, too.

Measures

1. Install pulsation prevention device (air chamber).
2. Enlarge the diameter and shorten the length of the discharge piping.

• Prevention of overfeeding

Pump differential pressure > Inertial resistance P_i

- The larger one of the suction side or the discharge side

Overfeeding means excessive flow of the liquid due to abnormal functioning of the check valve caused by pulsation of the liquid in the piping. Check carefully in case the differential pressure is low and in case the piping is too long even with the differential pressure value at 0.03MPa.

Measures

1. Install air chamber. 2. Install back pressure valve

• Prevention of suction failure

$NPSH_a > NPSH_r$

$$NPSH_a = P_a - P_v \pm P_{hs} - P_{is} \text{ * MPa}$$

*Or P_{fs} : whichever is the larger.
(NPSH: Net positive suction head)

If $NPSH_a$ is insufficient, caution should be exercised because draining or cavitation occurs, which may result in poor performance or pump damage.

- $NPSH_a$: Absolute NPSH (MPa)
- $NPSH_r$: Required NPSH (value particular to the pump) (MPa)
- P_a : Absolute pressure onto the tank liquid surface (MPa)
- P_v : Liquid vapour pressure (MPa)
- P_{hs} : Pressure caused by the height of the suction side (MPa)
(Flooded suction : +, Negative suction : -)
- P_{is} : Inertial resistance on the suction side (MPa)
- P_{fs} : Piping resistance on the suction side (MPa)

LK Series Performance

Model	Viscosity ^{Note3} mPa·s		Slurry (Calcium hydroxide) ^{Note3} wt%		NPSHr MPaA	Inertial resistance ^{Note1} MPa/1m		Applicable chambers ^{Note2} (0.3MPa)		
	PVC	SUS	PVC	SUS		50Hz	60Hz	PVC	SUS	
LK- 11	VC: 300 V6:500	500	—		0.07	0.001	0.001	1L	0.5L	
21			—							
22			—							
31		1000	5	—		0.08	0.003	0.004	2L	1.5L
32				—						
45			15	—		0.07	0.002	0.003	5L	5L
47				—						
55				—						
57				—						
LK-A 55	500	1000	15	15	0.08	0.003	0.004	5L	5L	
57						0.010	0.015			
65						0.004	0.005			
LK-B 65	500	1000	15	15	0.08	0.004	0.005	10L	10L	
75						0.003		20L	20L	
LK-C 76	500	1000	15	15	0.08	0.007	0.009	20L	20L	
86							0.010			
87							0.013			0.020

• Discharge capacity may reduce when sending viscous/slurry liquid. • Dosing flow fluctuation: ±2%FS • Linearity deviation: ±3%FS
 • Permissible liquid temperature PVC: 0 - 50°C, SUS: 0 - 80°C • Maximum suction lift: 1m at full stroke length • Permissible ambient temperature: 0 - 40°C • Paint color: H37-60D(JPMA)
 Note 1: Inertial resistance Pi is calculated per 1m on condition that the pipeline has the same bore as the pump (by pumping clean water at full stroke length). Determine the actual Pi by the following formula.
 Inertial resistance Pid(Pis)=Applicable Pi on the table×specific gravity×actual pipe length(m).....(MPa) (Pid:Discharge side Pi, Pis=Suction side Pi)
 If pipe bore is different from the pump bore:
 Inertial resistance Pid(Pis)=Applicable Pi on the table×specific gravity×actual pipe length×(Pump bore÷pipe bore)2.....(MPa)
 Note 2: Applicable chamber: Chamber volume is based on IWAKI's standard chambers
 Note 3: Use this as a guideline for transferring viscous liquids and slurry liquids. If the viscosity exceeds 300 mPa · s, please contact us.

LK-VS Type (Viscosity/Slurry)

Model	Connection		Viscosity mPa·s	Slurry wt%	Materials		
	flange	hose			valve seat	valve guide	
LK- 11VS	15A	*Ø12 x Ø18	1000	5	*SUS304	*PVC (For VS)	
2□VS		Normal		15			
3□VS							
45VS		*25A					*Hose cannot be used
45VS		25A (Normal)					-
5□VS	See the standard flange connection	-	1000		15	*SUS304	PVC (Normal)
A□VS							
B□VS							
C□VS							

• The information marked with * are for the VS type only.
 • Suction-side piping should be flooded suction system.

Inverter Control of LK Series

In case of inverter-applied control of the discharge, the control range may be different according to the types or the pressure employed.

List of the Specifications for the Selection of LK Series Inverter Control System

Model	Capacity ^{Note1} Full stroke length L/min	Max. Pressure MPa		Control range ^{Note2}	Stroke speed spm	Inverter frequency Hz	Motor ^{Note3}	Description	
		PVC, PVDF	SUS						
LK-	11	0.008 - 0.032	1.0	1.5	1 : 4	19 - 78	20 - 80	0.2kW Standard motor (IWAKI original flange motor)	1. The frequency less than the lowest in the table cannot be used as unstable rotation of motor is expected. 2. Drive over the max. frequency cannot be made. 3. Inverter motor cannot be installed.
	21	0.02 - 0.08							
	22	0.04 - 0.12							
	31	0.10 - 0.40							
	32	0.20 - 0.60	0.8	0.8	1 : 3	38-116	20 - 60		
	45	0.33 - 1.3							
	47	0.66 - 2.0							
	55	1.37 - 4.4	0.3	0.3	1 : 3.2	24 - 78	25 - 80		
	57	3.6 - 7.2							
LK-F	11	0.002 - 0.024	1.0	1.5	1 : 10	5 - 58	6 - 60 ^{Note4}	0.4kW	1. The frequency less than the lowest should not cause trouble in operation. However, such a level may affect the stability of the pump's performance.
	21	0.006 - 0.06							
	22	0.012 - 0.12				11 - 116	6 - 60		
	31	0.03 - 0.3				5 - 58	6 - 60 ^{Note4}		
	32	0.06 - 0.6	1.0	1.0	1 : 10	5 - 58	6 - 60		
	45	0.1 - 1.0				-	1.5		
	47	0.2 - 2.0	0.8	0.8	1 : 10	11 - 116	6 - 60		
	55	0.33 - 3.3	0.3	0.3	1 : 10	5 - 58	6 - 60 ^{Note4}		
		0.66 - 3.3	0.5	0.5	1 : 5	11 - 68	12 - 60		
	57	0.72 - 7.2	0.2	0.2	1 : 10	11 - 116	6 - 60		
		1.2 - 7.2	0.3	0.3	1 : 6	19 - 116	10 - 60		
	LK-A	55	1.1 - 4.4	0.3	0.3	1 : 4	20 - 78		
1.4 - 4.4			0.5	0.5	1 : 3.2	25 - 78	25 - 80		
57		1.8 - 7.2	0.3	0.3	1 : 4	29 - 116	15 - 60		
		3.6 - 7.2	0.5	0.5	1 : 2	58 - 116	30 - 60		
65		4.5 - 14.4	0.2	0.2	1 : 3.2	25 - 78	25 - 80		
LK-B	65	3.7 - 14.5	0.3	0.3	1 : 4	20 - 78	20 - 80	0.75kW	2. Drive over the max. frequency cannot be used.
		4.6 - 14.5	0.5	0.5	1 : 3.2	24 - 78	25 - 80		
	75	6.7 - 21.5	0.3	0.3					
LK-C	76	8 - 24	0.5	0.5	1 : 3	28 - 86	20 - 60	1.5kW	
	86	13 - 40	0.3	0.3					
	87	18 - 54	0.3	0.3		38 - 116			

Note 1: The capacity is the value when the maximum discharge pressure is applied in each type (with pure water at room temperature)

Note 2: With the LK-F type, a larger control range than 1 : 10 is available. In this case, however, the discharge accuracy and the linearity may be affected due to a stroke speed as low as 15 spm.

Note 3: The standard inverter is the Toshiba VF motor. In case of another motor used, most of the data in this list can still be used. To be sure, please contact your distributor in advance. An inverter control with an ordinary general-purpose motor should not be employed, because it may result in trouble in the low speed range.

Note 4: When combining the following materials, the inverter frequency is "10 to 60 Hz". LK-F11VS, LK-F21VS, LK-F31VS

• This table is applied to 200V range inverter. Ask us for the inverter of other voltage.

• Two-value control by inverter and electric servo can not be done.

• It may be necessary to adjust the output torque of the motor with the inverter.

Dimensions in mm

Dimensions may be changed without prior notice for the purpose of product improvement. Be sure to carry out installation work with the most recent and detailed drawings.

LK-11 to LK-57 (Original motor type)

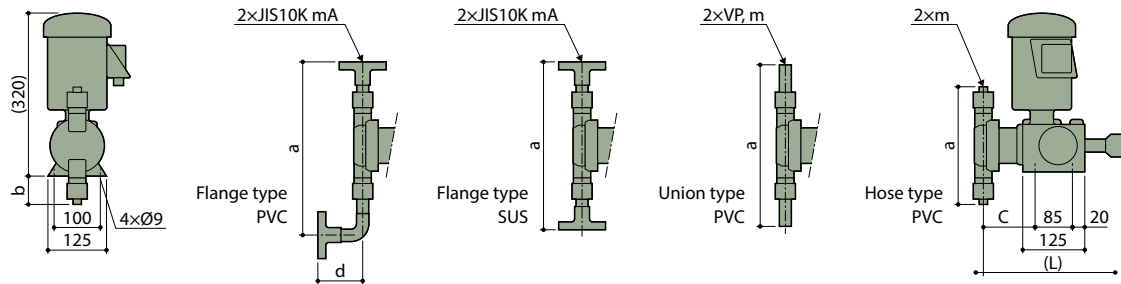

Model	Hose type					Union type					Flange type											
	PVC					PVC					PVC					SUS						
	L	a	b	c	m	L	a	b	c	m	L	a	b	c	d	m	L	a	b	c	m	
LK-1	274	146	23	95	Note 1	274	244	72	95	16	275	264	86	95	89	15	272	141	20	92	15	
2		164	32			262	81	277			282	95	277				151	25				
3		224	62			277	318	109			97	281	125				277	184	42			
4		249	75			281	342	120			99	281	135				283	261	80			101
5		-	-			298	314	107			114	298	125				295	320	111			111
47VS	-	-	281	272	86	99	25	281	313	106	99	97	25	-	-	-	-	-	-	-	-	

Note 1: Connection size LK-1 and LK-2 $\varnothing 4\text{mm} \times \varnothing 9\text{mm}$, LK-3, LK-4 and LK-1 to LK-45 VS type $\varnothing 12\text{mm} \times \varnothing 18\text{mm}$. For information of TC type, please contact IWAKI or nearest distributor.

LK-A55 to LK-C87 (General purpose motor type)

Model	PVC				SUS				Note2											
	L	a	b	c	L	a	b	c	H	d	e	f	g	m						
LK-A5	476	325	-29	119	473	320	-32	108	520	180	240	260	300	25						
A6	523	599	108	154	533	431	24	164												
B6	595		164	605	431	6	174													
B7	599	600	90	167	610	465	23	178							548	240	300	310	350	50
C7																				
C8	605	647	114	173	609	633	107	177							615					65

Note 2: These dimensions are common between PVC pump head and SUS pump head. For information of TC type, please contact IWAKI or nearest distributor.

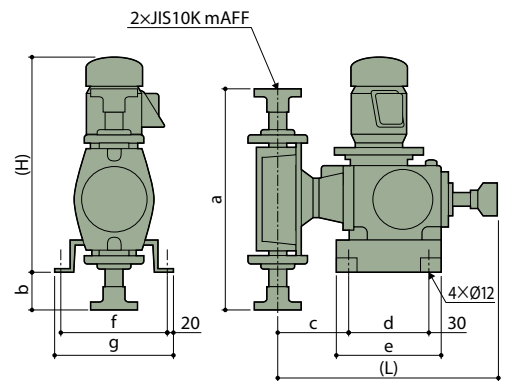

LK-F1 to F5 (General purpose motor type)

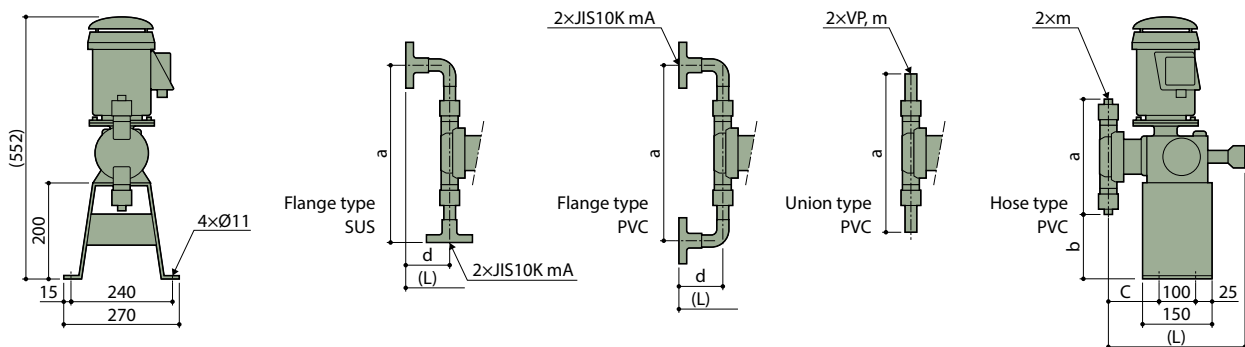

Model	Hose type					Union type					Flange type													
	PVC					PVC					PVC					SUS								
	L	a	b	c	m	L	a	b	c	m	L	a	b	c	d	m	L	a	b	c	d	m		
LK-F1	274	146	177	87	Note 1	274	244	128	87	16	363	272	114	87	89	15	332	156	180	85	60	15		
2		164	168			262	119	366			290	105	337				166	175						
3		224	138			277	318	91			89	366	350				75	89	337	201			158	90
4		249	128			281	342	79			92	370	369				65	92	343	270			120	94
5		-	-			298	314	93			107	395	350				75	107	399	368			90	104
47VS	-	-	281	272	114	92	25	378	313	94	92	97	25	-	-	-	-	-	-	-	-			

Note 1: Connection size LK-1 and LK-2 $\varnothing 4\text{mm} \times \varnothing 9\text{mm}$, LK-3, LK-4 and LK-1 to LK-45 VS type $\varnothing 12\text{mm} \times \varnothing 18\text{mm}$. For information of TC type, please contact IWAKI or nearest distributor.

Optional Accessories

Siphon preventing valve



Model	BVC-1P□L-□H		BVC-1P□-□H	
Applicable capacity	Up to 1L/min			
Setting pressure	0.05 - 0.2MPa		0.2 - 0.8MPa	
Material	PVC, FKM (EPDM)			
Connection mm (Applicable tube diameter)	Inlet	4 x 9, 12 x 18		
	Outlet	R3/8 and PT1/2		

□: Symbol for material of O-ring ("V" for FKM, "E" for EPDM)

Air chamber



PVC, A type



PVC, N type



SUS, A type



SUS, A type

Model	Body	Applicable capacity L	Setting pressure MPa	Connection Nominal size DIN PN 10 flange	Weight kg
A-1V□	PVC	1.0	0.5	Common for 15A - 25A	2
A-2V□		2.0			2.5
A-5V□		5.0			4.5
N40A-10V(2)-F*		10		40A	16
N50A-20V(2)-F*		20		50A	26
N65A-30V(2)-F*		30		65A	49
A-05S6-()	SUS316	0.5	0.9	10, 15, 20A	3
A-1S6-()		1.5		15, 20, 25A	5
A-5S6-()		5.0		25, 40A	12
A-10S6-()		10		40, 50A	15
A-20S6-()		20		50, 65A	29
A-36S6-()		36		65A	55

*: Material for O-ring 10V / 20V / 30V for CR, 10V2 / 20V2 / 30V2 for FKM

□: Symbol for material of O-ring ("V" for FKM, "E" for EPDM)

() : Symbol for connection (10, 15, 20, 25, 40, 50 or 65)

• The weight is the value of the product only. (The weight of liquid applied is not included.)

• Rigid PVC chamber may deteriorate with ultraviolet ray or the applied chemical liquid over a long period of time. The chamber should be replaced every three years to guarantee safety.

Relief valve and back pressure valve

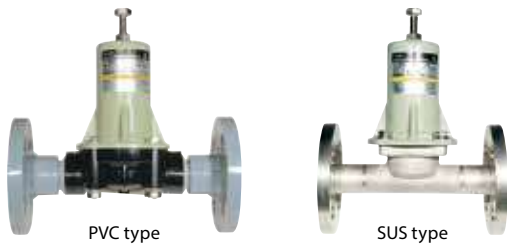

List of relief valve

Model	Body	Max. capacity L/min	Setting pressure MPa	Connection Nominal size DIN PN 10 flange, unless otherwise specified	Weight kg	
RV-1P□-4H	PVC	1.0	0.3 - 0.8	Ø4 x Ø9 PVC Hose	0.2	
RV-1P□-12H		1.0	0.3 - 0.8	Ø12 x Ø18 PVC Hose	0.2	
RV-1P□-15		1.0	0.3 - 0.8	15A	0.5	
RV-1P□-20		1.0	0.3 - 0.8	20A	0.5	
RV-1P□B -15		1.0	0.8 - 1.0	15A	0.5	
RV-3P-15		3.0	0.3 - 1.0	15A	0.6	
RV-3P 20		3.0	0.3 - 1.0	20A	0.6	
RV-3P-25		3.0	0.3 - 1.0	25A	0.9	
RV-3P□-12H		3.0	0.3 - 1.0	Ø12 x Ø18 PVC Hose	0.4	
RV-7V-20		7.5	0.3 - 0.8	20A	3.5	
RV-7V-25		7.5	0.3 - 0.8	25A	3.5	
RV-7V-20		7.5	0.8 - 1.0	20A	3.5	
RV-7VB-25		7.5	0.8 - 1.0	25A	3.5	
RV-25V-25		25	0.3 - 0.8	25A	4.0	
RV-25V-40		25	0.3 - 0.8	40A	4.0	
RV-25V-50		25	0.3 - 0.8	50A	4.5	
N50RV-5V-F		45	0.15 - 0.5	50A	18	
N50RV-5V2-F		45	0.15 - 0.5	50A	18	
N65•50RV-5V-F		65	0.15 - 0.5	65A	18	
N65•50RV-5V2-F		65	0.15 - 0.5	65A	18	
RV-2S6-15		SUS	2.0	0.3 - 0.8	JIS10 • 16K 15A	3.5
RV-2S6B-15			2.0	0.8 - 1.5	JIS10 • 16K 15A	3.5
RV-7S6-25			7.5	0.3 - 0.8	JIS10 • 16K 15A	6
RV-7S6B-25			7.5	0.8 - 1.5	JIS10 • 16K 15A	6
RV-25S6-25			25	0.3 - 0.8	25A	7.0
RV-25S6B-25			25	0.8 - 1.0	25A	7.0
RV-25S6-40			25	0.3 - 0.8	40A	7.5
RV-25S6-50			25	0.3 - 0.8	50A	8.7
RV-25S6B-40			25	0.8 - 1.0	40A	7.5
N50RV-5S6-F			80	0.15 - 0.5	50A	29
N65RV-5S6-F			120	0.15 - 0.5	65A	42

□: Symbol for material of O-ring ("V" for FKM, "E" for EPDM)
 O-ring material or N type is FKM for "5V2".
 Note: Material for diaphragm is PTFE except RV-1P and N type.
 O-Ring material for "RV-1P" and "N" type is same as diaphragm material.

List of back pressure valve

Model	Body	Flow range L/min	Setting pressure MPa	Connection Nominal size DIN PN 10 flange, unless otherwise specified	Weight kg	
BV-1P□-4H	PVC	0.005 - 1.0	0.2 - 0.8	Ø4 x Ø9 PVC Hose	0.2	
BV-1P□-12H		0.005 - 1.0	0.2 - 0.8	Ø12 x Ø18 PVC Hose	0.2	
BV-1P□-15		0.005 - 1.0	0.2 - 0.8	15A	0.5	
BV-1P□-20		0.005 - 1.0	0.2 - 0.8	20A	0.5	
BV-1P□L-4H		0.005 - 1.0	0.05 - 0.2	Ø4 x Ø9 PVC Hose	0.2	
BV-1P□L-12H		0.005 - 1.0	0.05 - 0.2	Ø12 x Ø18 PVC Hose	0.2	
BV-1P□L-15		0.005 - 1.0	0.05 - 0.2	15A	0.5	
BV-1P□L-20		0.005 - 1.0	0.05 - 0.2	20A	0.5	
BV-3P□-12H		3.0	0.3 - 1.0	Ø12 x Ø18 PVC Hose	0.4	
BV-3N□-12H		3.0	0.3 - 1.0	Ø12 x Ø18 PVC Hose	0.4	
BV-3N□-15		3.0	0.3 - 1.0	15A	0.6	
BV-3N□-20		3.0	0.3 - 1.0	20A	0.6	
BV-3N□-25		3.0	0.3 - 1.0	25A	0.9	
BV-7V-20		7.5	0.3 - 0.8	20A	3.5	
BV-7V-25		7.5	0.3 - 0.8	25A	3.5	
BV-25V-25		25	0.3 - 0.8	25A	4	
BV-25V-40		25	0.3 - 0.8	40A	4	
BV-25V-50		25	0.3 - 0.8	50A	4.5	
N50BV-5V-F		45	0.15 - 0.5	50A	18	
N50BV-5V2-F		45	0.15 - 0.5	50A	18	
N65•50BV-5V-F		65	0.15 - 0.5	65A	20	
N65•50BV-5V2-F		65	0.15 - 0.5	65	20	
BV-2S6-15		SUS	0.02 - 2.0	0.05 - 0.8	JIS10 • 16K 15A	3.5
BV-7S6-25			7.5	0.2 - 7.5	JIS10 • 16K 25A	6.0
BV-25S6-25			25	2 - 25	25A	7.0
BV-25S6-40			25	2 - 25	40A	7.5
BV-25S6-50			25	2 - 25	50A	8.5
N50BV-5S6-F			80	2.5 - 80	50A	29
N65BV-5S6-F			120	5 - 120	65A	42

□: Symbol for material of O-ring ("V" for FKM, "E" for EPDM)
 O-ring material or N type is "5V" for CR, or "5V2" for FKM.
 • Material for diaphragm is PTFE except BV-1P and N type.
 Material of diaphragm is same as O-ring material at BV-1P and N type.
 • The back pressure valve can not curb the residual flow completely when the pump stops. Use the solenoid valve in order to shut out the residual flow.

IWAKI CO., LTD. 6-6 Kanda-Sudacho 2-chome Chiyoda-ku Tokyo 101-8558 Japan TEL : (81)3 3254 2935 FAX : 3 3252 8892 IWAKI has global net work. www.iwakupumps.jp

European Headquarter	IWAKI Europe GmbH	TEL: (49)2154 9254 0	FAX: (49)2154 9254 48	U.S.A.	IWAKI America Inc.	TEL: (1)508 429 1440	FAX: (1)508 429 1386
Germany	IWAKI Europe GmbH	TEL: (49)2154 9254 50	FAX: (49)2154 9254 55	Brazil	IWAKI Do Brasil Comercio De Bombas Hidraulicas LTDA.	TEL: (55)19 3244 5900	FAX: (55)19 3244 5900
The Netherlands (Netherlands Branch)	IWAKI Europe GmbH	TEL: (31)74 2420011	FAX: (49)2154 9254 48	China (Shanghai)	IWAKI Pumps (Shanghai) Co., Ltd.	TEL: (86)21 6272 7502	FAX: (86)21 6272 6929
Italy (Italy Branch)	IWAKI Europe GmbH	TEL: (39)0445 561219	FAX: (39)0445 569088	China (Hong Kong)	IWAKI Pumps Co., Ltd.	TEL: (852)2607 1168	FAX: (852)2607 1000
Spain (Spain Branch)	IWAKI Europe GmbH	TEL: (34)934 741 638	FAX: (34)934 741 638	China (Guangzhou)	GFTZ IWAKI Engineering & Trading Co., Ltd.	TEL: (86)20 84350603	FAX: (86)20 84359181
Poland (East Europe Branch)	IWAKI Europe GmbH	TEL: (48)12 347 0755	FAX: (48)12 347 0900	China (Shenzhen)	IWAKI Pumps (Shenzhen) Co., Ltd.	TEL: (86)0755 8656 3696	
Denmark	IWAKI Nordic A/S	TEL: (45)48 242345		Singapore	IWAKI Singapore Pte Ltd.	TEL: (65)6316 2028	FAX: (65)6316 3221
Finland	IWAKI Suomi Oy	TEL: (358)10 201 0490		Indonesia (Indonesia Office)	IWAKI Singapore Pte Ltd.	TEL: (62)21 6906606	FAX: (62) 21 6906612
Norway	IWAKI Norge AS	TEL: (47)23 38 49 00		Malaysia	IWAKI SDN. BHD.	TEL: (60)3 7803 8807	FAX: (60)3 7803 4800
Sweden	IWAKI Sverige AB	TEL: (46)8 511 72900		Korea	IWAKI Korea Co.,Ltd.	TEL: (82)2 6238 4800	FAX: (82)2 6238 4801
Belgium	IWAKI Belgium N.V.	TEL: (32)13 670200	FAX: (32)13 672030	Taiwan	IWAKI Pumps Taiwan Co., Ltd.	TEL: (886)2 8227 6900	FAX: (886)2 8227 6818
France	IWAKI France S.A.	TEL: (33)1 69 63 33 70	FAX: (33)1 64 49 92 73	Thailand	IWAKI (Thailand) Co.,Ltd.	TEL: (66)2 322 2471	FAX: (66)2 322 2477
				Australia	IWAKI Pumps Australia Pty Ltd.	TEL: (61)2 9899 2411	FAX: (61)2 9899 2421

 **Caution for safety use:** Before use of pump, read instruction manual carefully to use the product correctly. Actual pumps may differ from the photos. Specifications and dimensions are subject to change without prior notice. For further details please contact us.

 **Legal attention related to export.** Our products and/or parts of products fall in the category of goods contained in control list of international regime for export control. Please be reminded that export license could be required when products are exported due to export control regulations of countries. The posting and copying from this catalogue without permission is not accepted firmly.